

OMRON

Programmable Controller

SYSMAC CJ1



New Flagship "R" CPU Units:
The Ultimate in Speed



realizing

The Fast, Small, and Flexible CJ1 the World of Machine Control!

Fast!

Versatile Machine Control with the Highest Performance Standards in the Industry.



Upgraded Basic Functions

(CJ1H-CPU6□H-R Performance)

Scan time	30 Ksteps in 870 μs
PC MIX values	17.7
Basic instructions	LD 16 ns/OUT 16 ns
Floating-point decimal instructions	Add/subtract: 0.24 μs Multiply: 0.24 μs
Interrupt response time	40 μs

● Conditions: 30 Ksteps, basic-to-special instruction ratio = 7:3, 128 inputs, 128 outputs

Small!

Super-compact design that meets the highest standards in its class. Even a narrow space in a machine serves as a control panel.



Height: 90 mm, Depth: 65 mm

Backplane-free structure for a flexible Rack width.

Smaller Units.

Expands

Flexible!

Suitable for essentially any application, from small device and temperature control, to large-scale control over networks.



Wide Range of CPU Units

Program capacity:	5 to 250 Ksteps
I/O points:	160 to 2,560 points
Data memory capacity:	32 to 448 Kwords

Application-specific CPU Units

CPU Units are available for a variety of applications, such as CPU Units with built-in I/O or CPU Units for loop control.

Full Complement of I/O Units

From Basic I/O Units, Analog Units, and Position Control Units to Ethernet Units, any of the Units can be used with any of the CPU Units.

C O N T E N T S

Concept	2
Application-specific CPU Units	8
CPU Units with Built-in I/O	8
Loop-control CPU Units	10
Function Blocks	12
Programming Languages	14
System Design Guide	17
System Configuration	18
Dimensions	22
General Specifications	25
CPU Units	27
Specifications	28
Additional CJ1M-CPU21/22/23 Specifications	32
CJ1G-CPU□□P (Loop-control CPU Units) Specifications	35
Checking Current Consumption and Power Consumption	36
Ordering Information	37
Basic Configuration Units	38
Programming Devices	42
Optional Products and Maintenance Products	45
DIN Track Accessories	45
Basic I/O Units	46
Special I/O Units and CPU Bus Units	50



Programmable Controller
SYNMAC CJ1

Fast!

Versatile Machine Control with the Highest Performance Standards in the Industry.

Small!

Super-compact design that meets the highest standards in its class. Even a narrow space in a machine serves as a control panel.

Expanding the Possibilities of Machine Control: Fast New Flagship "R" CPU Units for the CJ1 Series. **NEW**

Scan time	30 Ksteps in 870 μs
PCMIx values	17.7

•Conditions: 30 Ksteps, basic-to-special instruction ratio = 7:3, 128 inputs, 128 outputs

Model	User Memory	Data Memory
CJ1H-CPU67H-R	250 Ksteps	448 words
CJ1H-CPU66H-R	120 Ksteps	256 words
CJ1H-CPU65H-R	60 Ksteps	128 words
CJ1H-CPU64H-R	30 Ksteps	64 words



Compact Size Saves Space when Incorporated into Machines. Contributes to Size Reduction in Devices and to Space Savings in Control Panels.

Super Compact: Only 90 mm High and 65 mm Deep. Can Be Mounted in a Control Panel with Other Small Components.

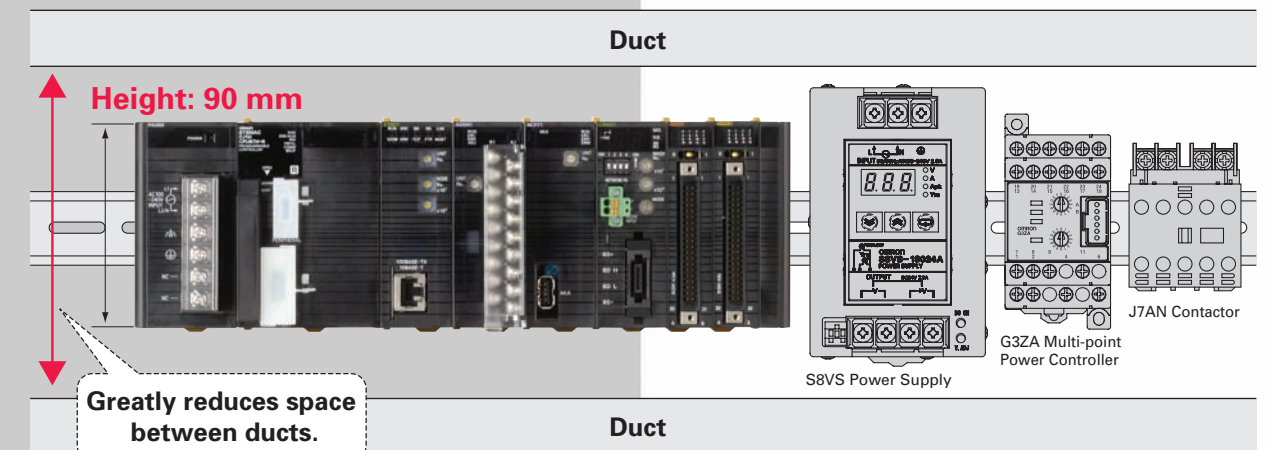

Backplane-free Structure Enables Flexible-width Design. Using I/O Units on Expansion Racks Further Improves Space Efficiency in Control Panels.

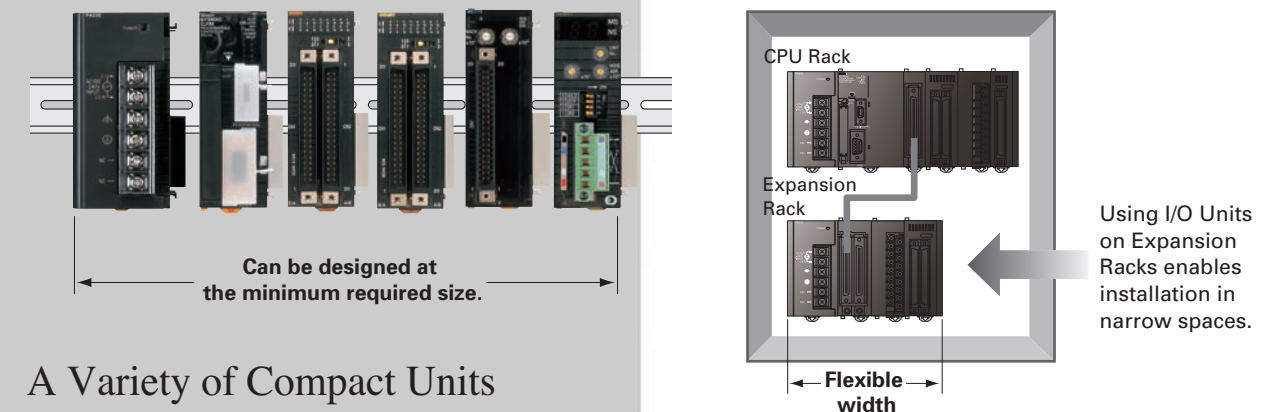

A Variety of Compact Units

● CPU Units
CJ1M-CPU11/12/13



31 mm

Only 31 mm in width, but an RS-232C port and Memory Card interface are standard.

● 20-mm-wide I/O Units
32-point Unit B7A Unit (64 points) CompoBus/S Master Unit

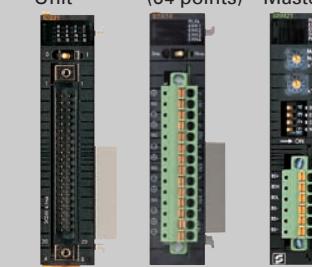

20 mm

Width can be minimized by using 20-mm-width I/O Units.

● 31-mm-width I/O Units
ID Sensor Unit (2 Channels) Temperature Control Unit (4 Loops)

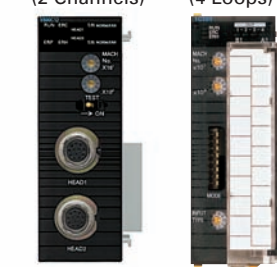

31 mm

A variety of Units are available for high-density mounting. Using Units for external devices enables further size reductions.

All Processes Speeded Up for Enhanced Application Performance.

Fast! System Overhead

Common processing	130 μs
Interrupt response	40 μs

Fast! Basic Instructions

LD instruction execution time	16 ns
OUT instruction execution time	16 ns

Fast! Floating-point Arithmetic

SIN calculation	0.59 μs
Floating-point decimal addition and subtraction	0.24 μs

Fast! I/O Refresh

Basic I/O Unit, 16 points	1.4 μs
Analog Input Unit, 8 points	50 μs

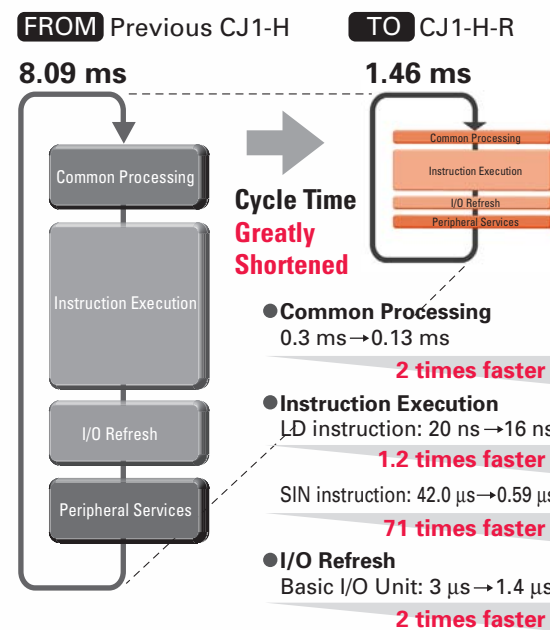

•Conditions: 30 Ksteps, basic-to-special-to-floating-point decimal instruction ratio = 6:3:1, 128 inputs, 128 outputs, 2 Analog Input Units, 2 Position Control Units (4-axis Units)

Flexible

Suitable for any application, from small device and temperature control, to large-scale control over networks.

A Wide Variety of CPU Units and Other Units to Handle Virtually Any Type of Machine Control.

A Complete Lineup of CPU Units, from Low-end to High-end

Despite the wide variety of models, memory allocations, instructions, and I/O Units are all compatible. This makes it easy to design migration from large-scale systems to small devices.

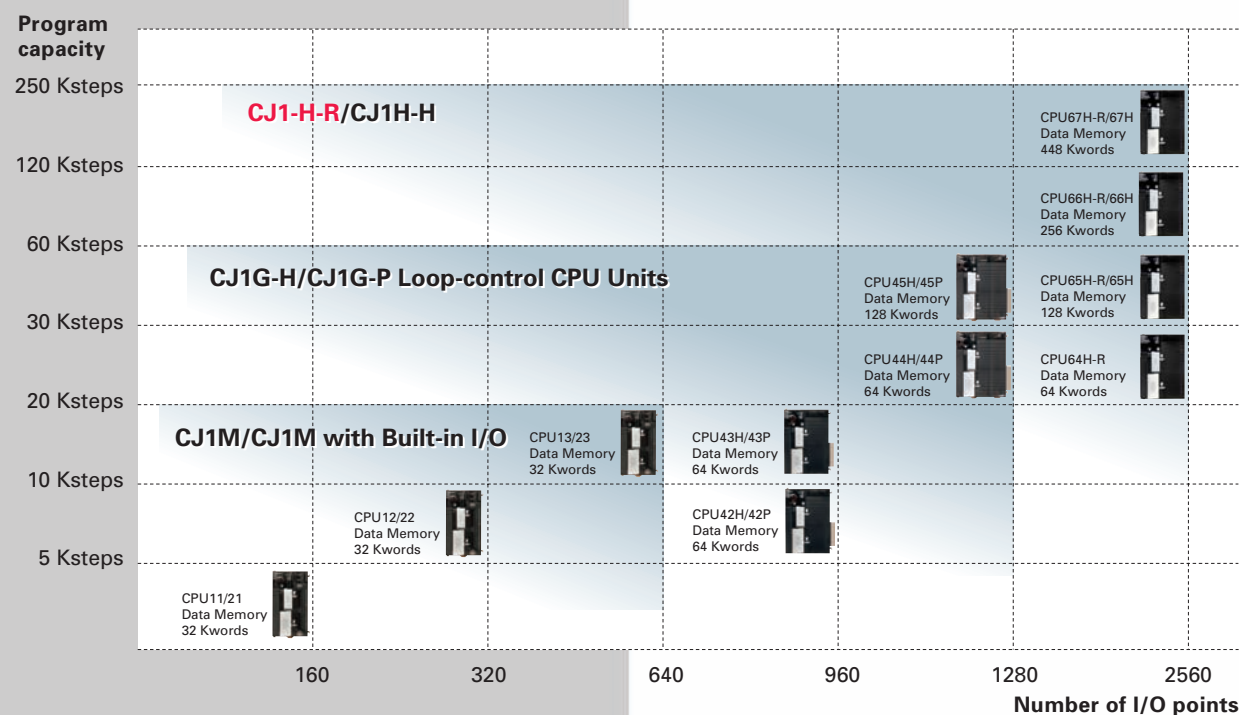

A Wide Selection of CPU Units to Match the Application

Select the optimum CPU Unit according to your system requirements.

CPU Unit	General-purpose CPU Units				Application-specific CPU Units	
	High-speed Models	Advanced Models	Standard Models	Compact Models	with Built-in I/O	Loop-control CPU Units
	For Applications Requiring Speed	For Large-scale Applications Requiring Large Memory Capacity	For Applications Requiring Large Memory Capacity, such as Data Management	For Small-scale Applications such as Automated Machines and Inspection Devices	For Applications Requiring Versatile, High-precision Position Control	For Applications Requiring Sequence Control and Analog Control
	CJ1H-CPU6□H-R	CJ1H-CPU6□H	CJ1G-CPU4□H	CJ1M-CPU1□	CJ1M-CPU2□	CJ1G-CPU4□P(-GTC)
Basic instructions	LD 16ns/OUT 16ns	LD 20ns/OUT 20ns	LD 40ns/OUT 40ns	LD 100ns/OUT 350ns	LD 100ns/OUT 350ns	LD 40ns/OUT 40ns
Program capacity	250 to 30 Ksteps	250 to 60 Ksteps	60 to 10 Ksteps	20 to 5 Ksteps	20 to 5 Ksteps	60 to 10 Ksteps
Data memory capacity	448 to 64 Kwords	448 to 128 Kwords	128 to 64 Kwords	32 Kwords	32 Kwords	128 to 64 Kwords
Number of I/O points	2,560	2,560	1,280 to 960	640 to 160	640 to 160	1,280 to 960
Width	62 mm	62 mm	62 mm	31 mm	49 mm	69 mm
Built-in I/O	None	None	None	None	16	None
Loop control	None	None	None	None	None	50 to 300 blocks

Wide Selection of Unit Groups

Choose from a wide range of Units, from Basic I/O Units, Analog Units, and Position Control Units to Ethernet Units. All can be used with any of the CPU Units.

Basic I/O Units

29 models total

A wide variety of products, such as high-density mountable connectors and removable terminal blocks, is available to meet your requirements.



Units for Special Applications

5 models total

Units, such as the B7A, are available for interrupt inputs, quick-response inputs, and reduced I/O wiring.



Analog, Process-control, and Temperature Control Units

22 models total

Input Units and Temperature Control Units are available to handle process data, such as temperatures, currents, and voltages. A complete lineup of models (including models with isolation between channels and high-precision models) is available for a wide range of applications.



Positioning Units

9 models total

Various Units are available for control from High-speed Counter Units to Position Control Units for open-collector and line-driver pulse outputs and MECHATROLINK-II communications and Motion Control Units for applications using motion language.

Note: MECHATROLINK-II is a registered trademark of the MECHATROLINK Members Association.



Communications Units

10 models total

Units are available for general-purpose Ethernet, as well as for data links between PLCs, and the DeviceNet and CompoNet open networks.



Other Units

5 models total

Units such as RFID Controllers and Data Collection Units are available to meet a wide range of needs.



Application-specific CPU Units

Achieve More Flexible and Precise Machine Control with Built-in Pulse I/O.

CPU Unit



CPU Units with Built-in I/O

CJ1M-CPU2

High-speed, Flexible Programming Is Made Easy by Simply Pasting OMRON Function Blocks for Positioning.

Built-in I/O

Input interrupts: 4 points
High-speed counter inputs: Single-phase, 100 kHz, 2 axes or Differential phases, 50 kHz, 2 axes
Pulse outputs: 100 kHz, 2 axes
One PWM output (CPU21)
Two PWM outputs (CPU22/CPU23)

Note: The above functions can all be used simultaneously.

Product Variations

Model	User memory	Data memory
CJ1M-CPU21	5 Ksteps	32 Kwords
CJ1M-CPU22	10 Ksteps	32 Kwords
CJ1M-CPU23	20 Ksteps	32 Kwords

Input Interrupts

Up to four interrupt inputs or quick-response inputs can be used.
● For quick-response inputs, detection is possible for pulse

- Widths as short as 30 μs.
Interrupt response uses high-speed response
- Processing at 93 μs.
Interrupts can be created for ON signals or OFF signals.

High-speed Counters

Up to two high-speed counter inputs can be used by connecting rotary encoders to built-in inputs.
● High-speed counting for a 24-VDC input at 60 kHz for single-phase and 30 kHz for differential phases.

- High-speed counting for line-driver inputs at 100 kHz for single-phase and 50 kHz for differential phases.

High-speed Counter in Linear Mode

Ideal for applications such as conveyors.

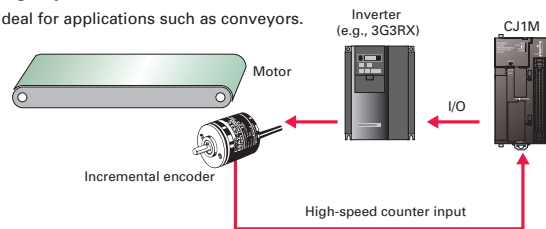

High-speed Counter in Linear Mode

Ideal for applications such as electronic component index tables.

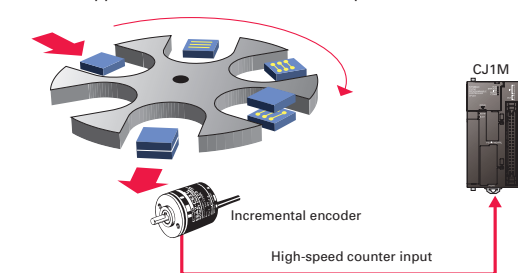

- High-speed interrupts can be processed using target value matching or zone comparison interrupts.
- The frequency (speed) can be easily measured by using a special instruction (PRV2). Ideal for applications such as measuring the speed of rotating bodies for inspections or detecting conveyor speeds. Can also be used for monitoring accumulated motor rotations.

Pulse Outputs

From stepping motors to servos, positioning control can be easily achieved using pulse outputs for one or two axes.
● Pulse output control is enabled from 1 Hz to 100 kHz.
● Startup times as fast as 46 μs reduce tact times and enable high-precision positioning.
● A high-precision variable duty ratio (PWM) can be output in 0.1% increments and used in applications such as lighting and electric power control.
● Using special instructions and OMRON Function Blocks for positioning makes programming easy even for first-time users.

Origin Search

An origin search or return operation can be executed with a single command.
● A wide range of origin search patterns is available, so the optimum origin search pattern can be selected for the machine design.
● When a Servomotor is used, position deviation is minimized by a deviation counter reset output.

Positioning

Speed control or positioning using relative or absolute coordinates can be executed with a single command. A wide range of functions is available for positioning to suit your application.

Positioning control variations	Operation patterns	Application examples	Special instructions, OMRON Function Blocks
Trapezoidal Acceleration/Deceleration Positioning OMRON Function Blocks and special instructions make position control easy. Detailed functions are provided for reducing out-of-step operation for stepping motors and eliminating error downtime.	<ul style="list-style-type: none"> ● Basic Form Acceleration Start frequency Target speed control Specified number of travel pulses Deceleration ● Setting Acceleration and Deceleration Separately The optimum speed curve can be set according to acceleration and deceleration torque. ● S-curve Acceleration/Deceleration Setting Used to reduce vibration during high-speed positioning. ● Triangular Control A fatal error does not occur even if settings do not allow the target speed to be reached. 	Basic Conveyor Rail Width Positioning	Achieved with a single OMRON Function Blocks for specifying absolute (or relative) travel. <ul style="list-style-type: none"> • Move Absolute (REAL) • Move Absolute (DINT) • Move Relative (REAL) • Move Relative (DINT)
Changing the Target Position during Positioning The target position can be changed during positioning. It is also possible to reverse direction when changing the target position.		Position Control Using Data Measured at Startup	While position is being controlled by a PLS2 instruction, another PLS2 instruction can be used to override the first PLS2 instruction. <ul style="list-style-type: none"> • Starting Trapezoidal Control • Changing the Target Position with Another Instruction
Interrupt Feeding It is possible to change to positioning control during speed control. Interrupt feeding can be executed after the interrupt for a specified number of pulses.		High-precision Interrupt Positioning	Achieved with a single OMRON Function Block for interrupt feeding. <ul style="list-style-type: none"> • Interrupt Feeding (REAL) • Interrupt Feeding (DINT)
Sequential Positioning Travel to multiple preset points can be specified. This is effective for applications such as positioning loaders and unloaders at multiple points.		PCB Rack Positioning	Achieved with a single OMRON Function Block for specifying sequential positioning.

Application-specific CPU Units

Suitable for any application, from small device and loop control to

large-scale control over networks.

CPU Unit



Loop-control CPU Units

CJ1G-CPU4□P

CJ1G-CPU4□P-GTC

In Addition to Sequence Control, an Engine for Controlling Analog Quantities Is Built Into the CPU Unit.

Product Variations

Model	User Memory	Data Memory	Function blocks
CJ1G-CPU42P	10 Ksteps	64 Kwords	50
CJ1G-CPU43P	20 Ksteps	64 Kwords	300
CJ1G-CPU44P	30 Ksteps	64 Kwords	300
CJ1G-CPU45P	60 Ksteps	128 Kwords	300
CJ1G-CPU45P-GTC	60 Ksteps	128 Kwords	300

CPU Element: CJ1G-CPU4□H
CX-Programmer
Sequence Control Program (Ladder, FB, ST)

20-Step ladder program executed in 1 ms. (See note.) *Fast!*

Note: For basic instructions only.

Loop Controller Element: 50 or 300 Function Blocks
CX-Process
Loop Control Program (Function Blocks)

20 loops of PID control executed in 10 ms. (See note.) *Fast!*

Note: For a normal case. (Example: Single loop configuration, A14 terminal + segment linearizer + basic PID + Ao4 terminal)

Easy Programming Using Function Blocks

Programming is made easy by combining function blocks such as PID control and square root calculations and then connecting them with a mouse.

- Even complex control operations can be managed, such as program control, cascade control, and feed-forward control.
- PID parameters can be adjusted on the special Tuning Screens.

Engineering Example: Program Control

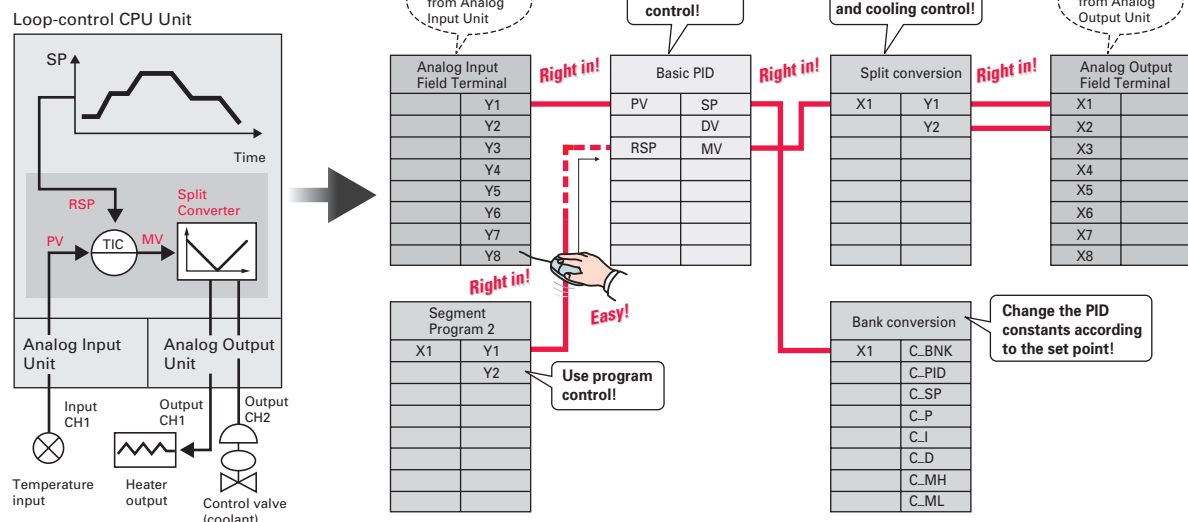

Tuning and Automatic Screen Generation

Tuning Screens that are convenient for adjusting PID parameters can be easily started. The screens required during operation can be automatically generated, thereby reducing development work.

- A Tuning Screen can be easily started by right-clicking the mouse over the function block.
- When combined with an NS-series PT, the touch panel screen required for loop control startup and operation is generated automatically with just one button.

CX-Process Tool (Software for Personal Computer)

① Combine function blocks and connect them graphically using the mouse.

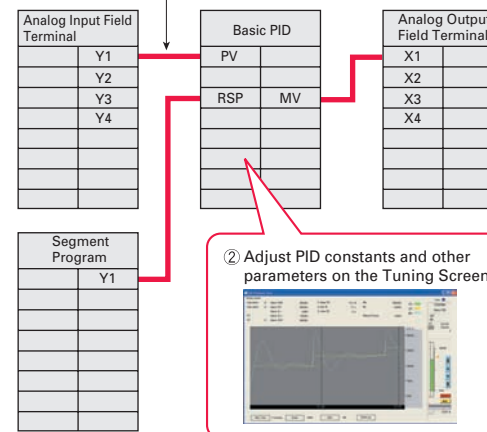

Face Plate Auto-Builder for NS

③ Touch panel windows are automatically generated.

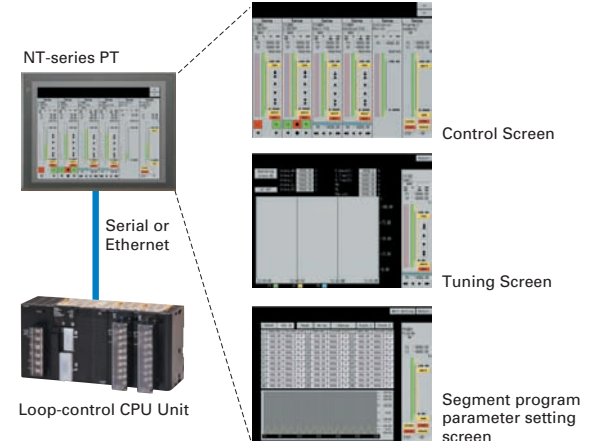

Temperature Control Algorithms with a Proven Track Record

OMRON's many years of accumulated know-how in temperature and process control have been condensed to create easy-to-use algorithms with proven results in providing solutions to problems.

New Algorithms for Stabilizing Control Adjusting for Disturbance Overshooting

A function is provided to suppress overshooting due to disturbances for faster stabilization.

Example

- Temperature drops when objects are placed in a batch furnace
- Disturbance when control is changed

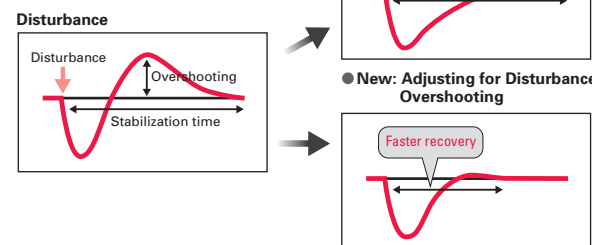

Optimum Tuning for the Application Fine-tuning Function

Values such as the PV, SP, and MV can be monitored and adjusted on the Tuning Screen, and the data can be saved as a CSV file. An auto-tuning (AT) function and a fine-tuning (FT) function are also supported for automatic calculation of PID constants.



Gradient Temperature Control for Planar Temperature Control Across Multiple Points (See note.)

Note: CJ1G-CPU45P-GTC only.

Gradient temperature control equalizes the temperatures at multiple points, providing high-quality heat processing, reducing energy loss until temperatures stabilize, and saving labor in adjustments due to interference between heaters.

Example: Planar Temperature Control of Multi-stage Furnaces, Wafer and Glass Surface Temperatures, and Other Applications.
CPU: CJ1G-CPU45P-GTC

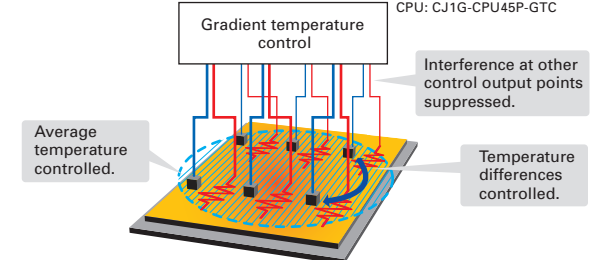

Function Blocks for High-quality Program Standardization and Structure

Function Block

Function block support is standard for all CJ1-series CPU Units. In addition, with unit version 4.0 of the CPU Unit, functions required for standardization and structure are further improved.

Function Block (FB)

Function blocks (FBs) are a method developed internationally for standardization of program modules.

- In contrast to the earlier subroutines and macro programs, function blocks are more easily reused and provide features that are more conducive to structured programming.
- Function blocks have spread to countries throughout the world. Although they are supported globally, local training and setting of operation rules are easy.

Creating Function Blocks

■ Registering Function Block Definitions

Register a master of the programming to be standardized. Classify the required I/O memory as inputs, outputs, and internal storage, and register the required variables accordingly.

■ Reusing Programming (Creating Instances)

First paste the function block into the Ladder Editor Window. Then complete the programming by assigning input and output variables for that function block.

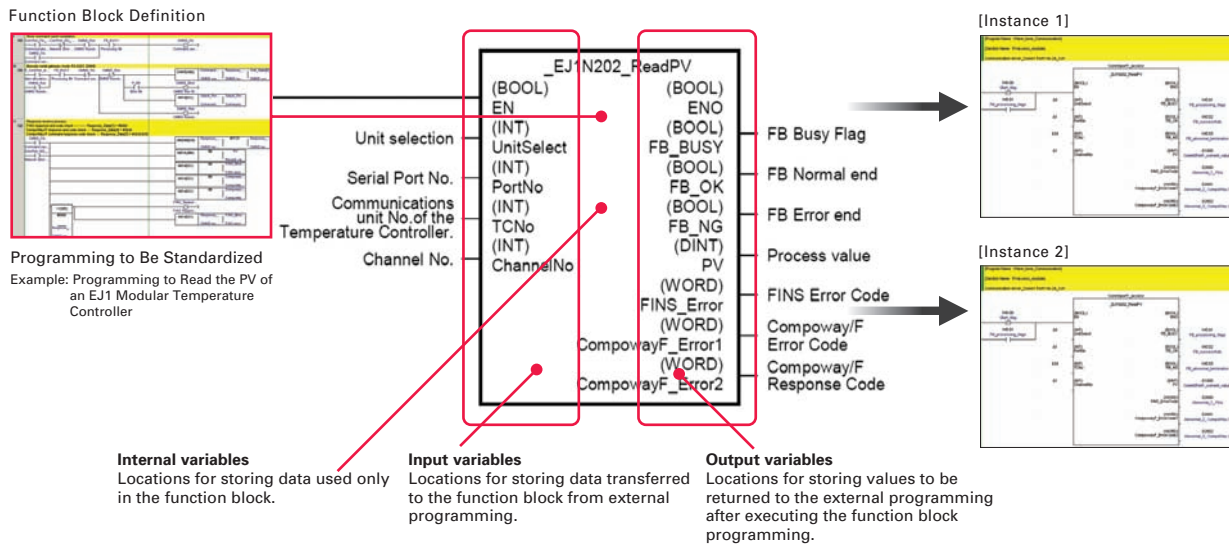

Same Debugging Functions as for Ladder Programs

- Function block internal program simulation, online corrections, and online additions are all supported.
- The efficiency of advance testing on the desktop and of debugging using actual devices is improved.

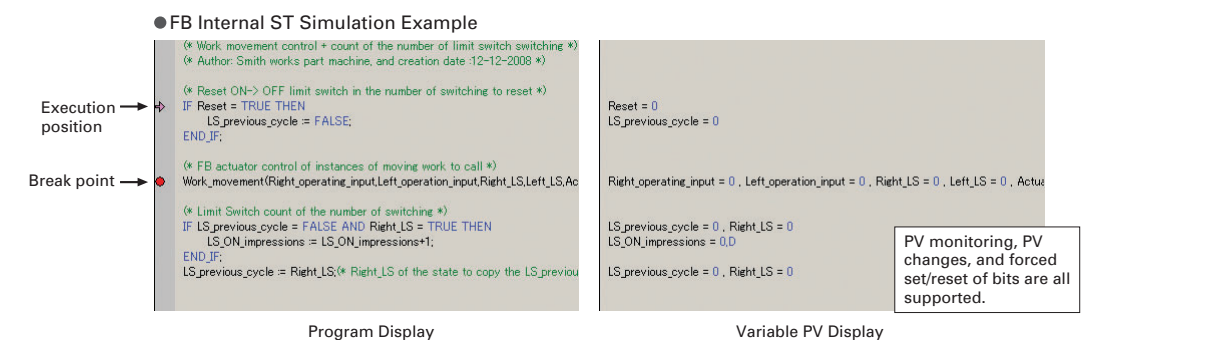

Program Standardization and Improved Reusability

Corrections to a function block definition are automatically reflected in all of the function block instances.

Correcting a function block definition at one place automatically makes the same correction in all the function block instances. Unlike macro programs, this prevents correction from being applied unevenly when reusing standard programming in multiple locations.

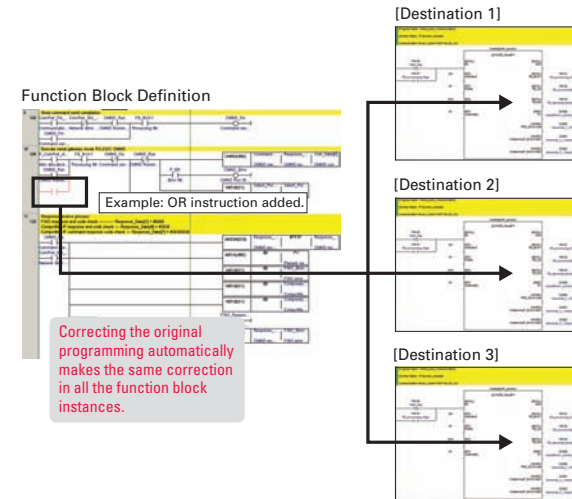

The required internal variables are automatically created when a function block instance is created.

Internal variables used exclusively in the function block are automatically allocated in I/O memory. This prevents accidental access from other function blocks or programs, and prevents the same memory location from being accidentally used for two different purposes.

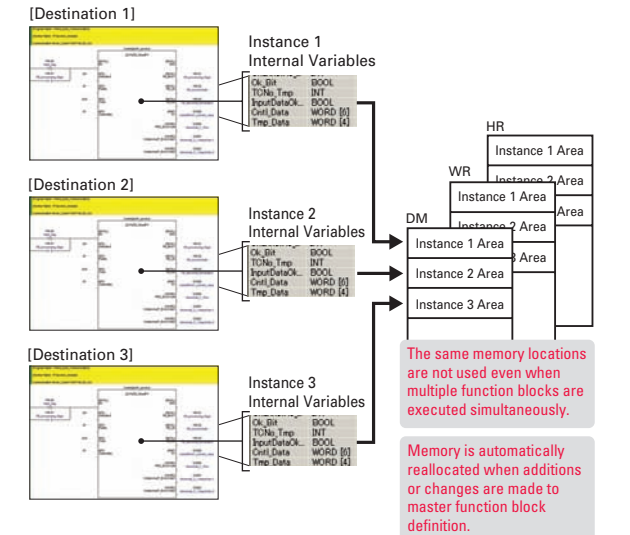

A Wide Range of Functions Required for Large-scale Structured Programming

Program nesting is supported for up to eight nesting levels.

Program nesting is required to make general-purpose low-level drivers as standard components and combine them in structured programming.

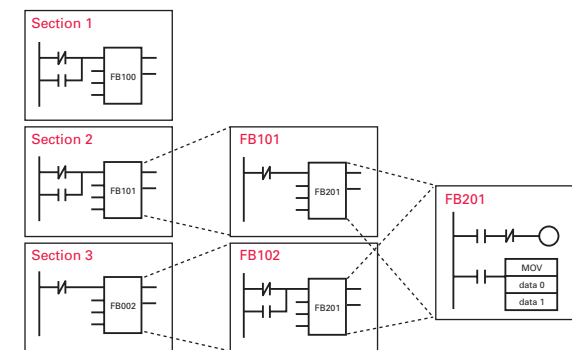

- **Overall Control Programming**
Programming for overall control that receives and manages commands from the host.
- **Programming for Each Control Function**
Programming for each positioning control axis and communications port.
- **Standard Device Driver**
Programming (e.g., an OMRON Function Block) at the command level at the bottom of the hierarchy.

Exchange of Large-capacity Table Data between Function Blocks (I/O Variables) (Unit Version 4.0 or Later) NEW

I/O variable addresses can now be passed to and from function blocks. Table data, such as device recipes and control parameters, can be easily transferred from external programming to function blocks.

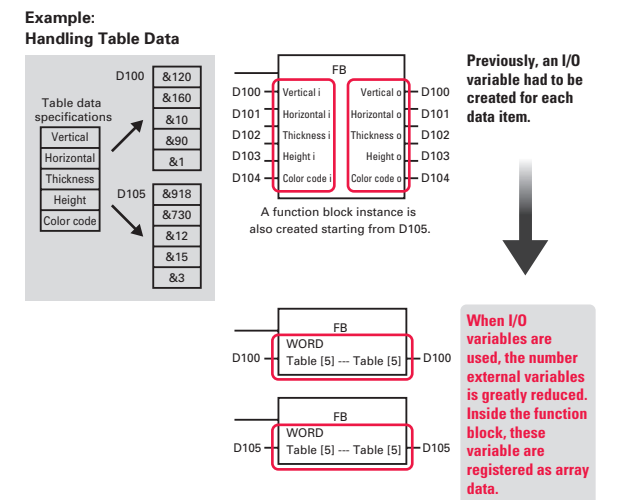

Note: For details on function blocks, refer to Function Block/Structured Text Introduction Guide (Cat. No. R144).

The Optimum Programming Language for such as Device Status Changes and Numeric

Various Control Functions, Processing Programming Language

Expanded Support for Languages Conforming to IEC 61131-3 Standard.
Greater Selection of Programming Languages for Various Applications

Sequential Function Chart (SFC) NEW (Unit Version 4.0 or Later)

The Sequential Function Chart (SFC) language is ideal for programming changes in system status.

- SFCs can be used to express changes in overall device processes, making it easy to perform debugging and maintenance for overall system operation.
- Parallel branching and joining of multiple processes executed in parallel, and conditional branching and joining of individually selected processes, can be written graphically.

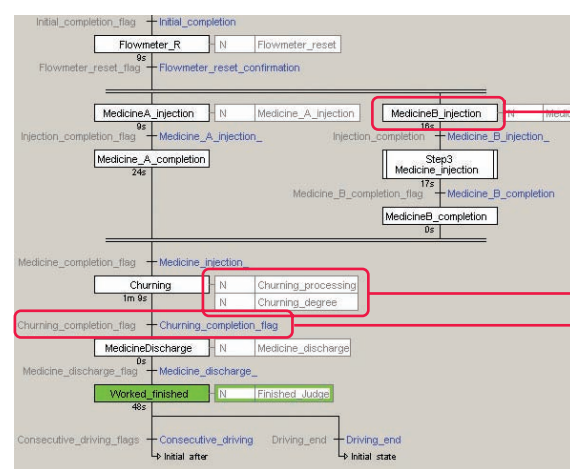

- **Step**
Expresses a single process within the overall processing. When a step is activated, the actions defined in that step are executed.
- **Action**
Expresses an individual process within a step. Actions can contain bits or programs. A number of different types of actions can be defined in a single step.
- **Transition**
Plays the role of a gate for moving the active status to the next step. The transition condition can be a bit or a program.

Ladder and ST language can be used for the action and transition programs, and can include function blocks.

SFC programming can use program components structured with function blocks to take advantage of the superior reusability of function blocks.

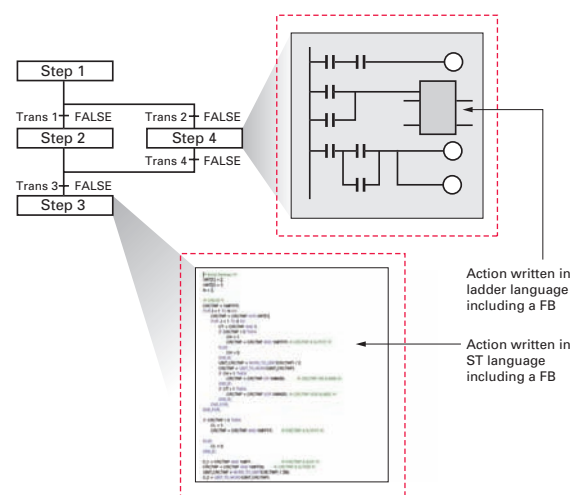

Superior debugging functions are supported, such as online editing and simulation.

SFC programming offers the same superior debugging functions as provided for ladder programming. In addition, forced setting and resetting are supported for steps and transitions.

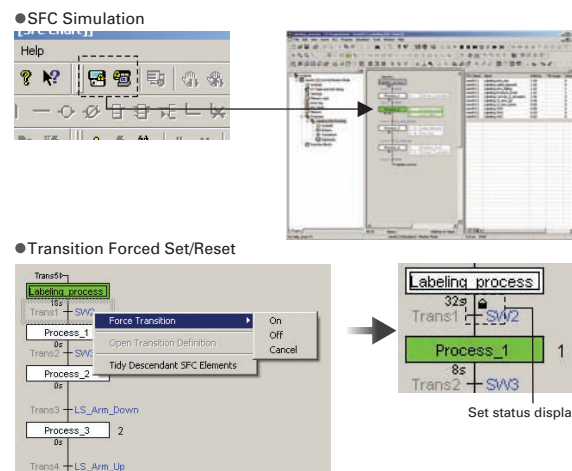

Note: For details on sequential function charts, refer to SFC Introduction Guide (Cat. No. R149).

Structured Text (ST)

Structured Text (ST) is a language developed for FA control and is effective for complex numeric and text-string processing.

- Programming such as conditional branching, repeated executions, and text-string control can be written more easily than with ladder programs.
- Because ST is a text language, maintenance and reusability are easy due to the high generality and readability.

```

Initial Settings
XMTD1 = 2;
XMTD2 = 7;
N = 2;

(* CRC16 *)
CRC16 = 16#FFFF;
FOR I = 1 TO N DO
  CRC16 = CRC16 XOR XMTD[I];
  FOR J = 1 TO 8 DO
    OT = CRC16 AND 1;
    IF CRC16 < 0 THEN
      CH = 1;
      CRC16 = CRC16 AND 16#7FFF; (* CRC16 & 0x7FFF *)
    ELSE
      CH = 0;
    END_IF;
    UINT_CRC16 = WORD_TO_UINT(CRC16) / 2;
    CRC16 = UINT_TO_WORD(UINT_CRC16);
    IF CH = 1 THEN
      CRC16 = CRC16 OR 16#4000; (* CRC16 OR 0x4000 *)
    END_IF;
    IF OT = 1 THEN
      CRC16 = CRC16 XOR 16#A001; (* CRC16 XOR 0xA001 *)
    END_IF;
  END_FOR;
END_FOR;

IF CRC16 < 0 THEN
  CL = 1;
  CRC16 = CRC16 AND 16#7FFF; (* CRC16 & 0x7FFF *)
ELSE
  CL = 0;
END_IF;

C1 = CRC16 AND 16#FF; (* CRC16 & 0xFF *)
CRC16 = CRC16 AND 16#7F00; (* CRC16 & 0x7F00 *)
UINT_CRC16 = WORD_TO_UINT(CRC16) / 256;
C2 = UINT_TO_WORD(UINT_CRC16);
    
```

- Example: Control Syntax
Conditional branching : IF, THEN, ELSE/CASE, ELSE
Repeated execution : FOR/WHILE loop
- Example: Numeric Processing Functions
Trigonometric functions : SIN, COS, TAN, ASIN, ACOS, ATAN
Absolute values : ABS
Logarithms : LOG, LN
Square roots : SQRT
Exponents : EXP, EXPT

Use ST Not Only in Function Blocks But Also in Tasks (Unit Version 4.0 or Later) NEW

The ST language can be used according to the application, e.g., in function blocks for program standardization or in tasks for programming specific applications. The ST language can also be used to call function blocks, as well as for structuring program resources.

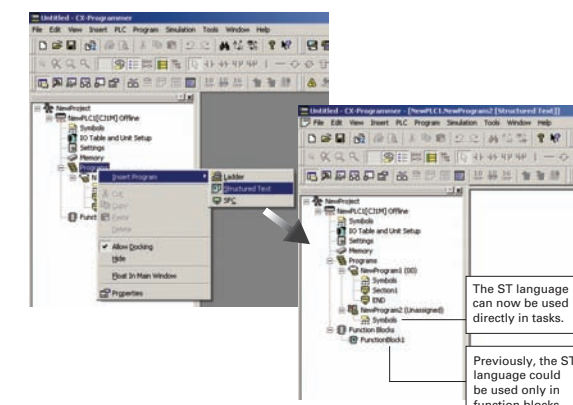

Note: For details on Structured Text (ST), refer to Function Block/Structured Text Introduction Guide (Cat. No. R144).

Convenient for text strings used for PTs and BCR. The STRING data type is supported. (Unit version 4.0 or later) NEW

Text string data can be written directly into programs, allowing the data to be intuitively understood.

Information stored as text strings acquired from a bar code reader can be displayed on a PT.

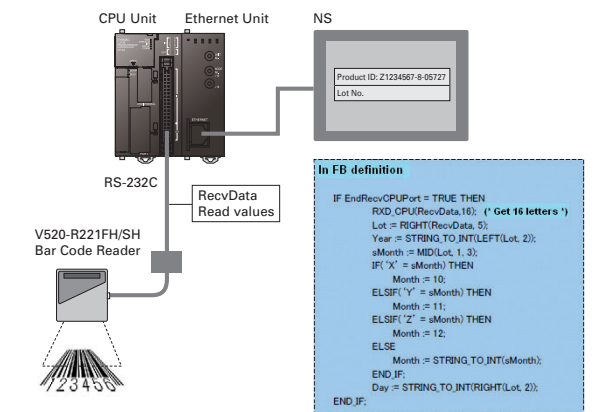

System Design Guide

System Configuration	18
Dimensions	22
General Specifications	25
CPU Units	27
Specifications	28
Additional CJ1M-CPU21/22/23 Specifications	32
CJ1G-CPU□□P (Loop-control CPU Units) Specifications	35
Checking Current Consumption and Power Consumption	36

System Configuration

Basic System

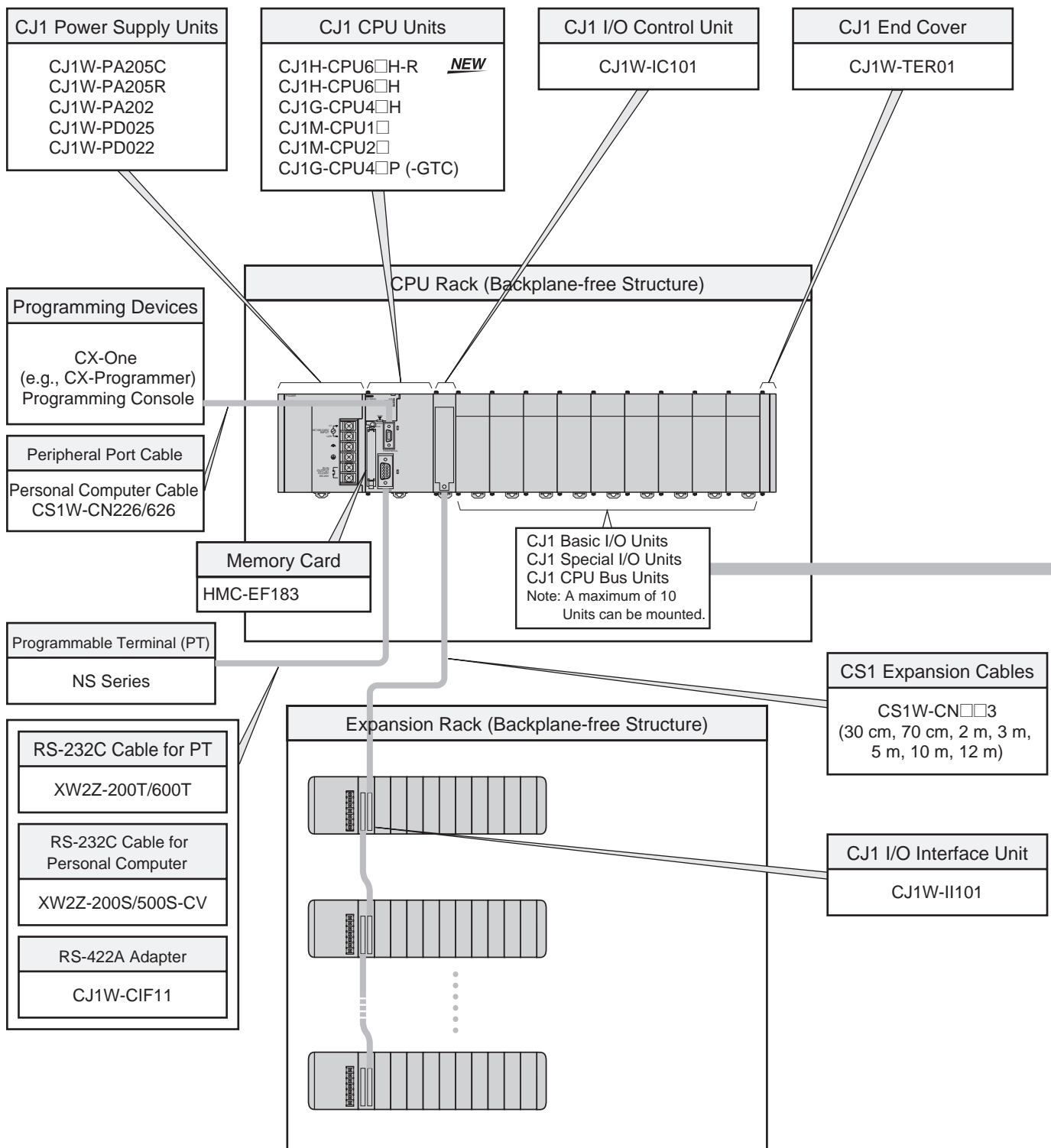

■ Configuration Units

CJ1 Basic I/O Units			
8-point Units	16-point Units	32-point Units	64-point Units
Input Units			
<ul style="list-style-type: none"> ● DC Input Unit CJ1W-ID201 ● AC Input Unit CJ1W-IA201 	<ul style="list-style-type: none"> ● DC Input Unit CJ1W-ID211 ● AC Input Unit CJ1W-IA111 	<ul style="list-style-type: none"> ● DC Input Unit CJ1W-ID231 CJ1W-ID232 	<ul style="list-style-type: none"> ● DC Input Unit CJ1W-ID261 CJ1W-ID262
Output Units			
<ul style="list-style-type: none"> ● Transistor Output Units CJ1W-OD201 CJ1W-OD202 ● Triac Output Unit CJ1W-OA201 ● Relay Contact Output Unit (independent commons) CJ1W-OC201 	<ul style="list-style-type: none"> ● Transistor Output Units CJ1W-OD211 CJ1W-OD212 ● Relay Contact Output Unit CJ1W-OC211 	<ul style="list-style-type: none"> ● Transistor Output Units CJ1W-OD231 CJ1W-OD232 CJ1W-OD233 	<ul style="list-style-type: none"> ● Transistor Output Units CJ1W-OD261 CJ1W-OD262 CJ1W-OD263
I/O Units			
---	---	(16 inputs, 16 outputs) <ul style="list-style-type: none"> ● DC Input/Transistor Output Units CJ1W-MD231 CJ1W-MD232 CJ1W-MD233 	32 inputs, 32 outputs <ul style="list-style-type: none"> ● DC Input/Transistor Output Units CJ1W-MD261 CJ1W-MD263 32 inputs, 32 outputs <ul style="list-style-type: none"> ● TTL I/O Unit CJ1W-MD563
Other Units			
---	<ul style="list-style-type: none"> ● Interrupt Input Unit CJ1W-INT01 	---	<ul style="list-style-type: none"> ● B7A Interface Units (64 inputs) CJ1W-B7A14 (64 outputs) CJ1W-B7A04 (32 inputs, 32 outputs) CJ1W-B7A22
	<ul style="list-style-type: none"> ● High-speed Input Unit CJ1W-IDP01 		

CJ1 Special I/O Units and CPU Bus Units			
<ul style="list-style-type: none"> ■ Process I/O Units ● Isolated-type Units with Universal Inputs CJ1W-PH41U Available soon CJ1W-AD04U Available soon ● Isolated-type Thermocouple Input Units CJ1W-PTS15 CJ1W-PTS51 ● Isolated-type Resistance Thermometer Input Units CJ1W-PTS16 CJ1W-PTS52 ● Isolated-type DC Input Unit CJ1W-PDC15 ■ Analog I/O Units ● Analog Input Units CJ1W-AD081-V1 CJ1W-AD041-V1 ● Analog Output Units CJ1W-DA08V CJ1W-DA08C CJ1W-DA041 CJ1W-DA021 ● Analog I/O Units CJ1W-MAD42 ■ Temperature Control Units CJ1W-TC001, CJ1W-TC002 CJ1W-TC003, CJ1W-TC004 CJ1W-TC101, CJ1W-TC102 CJ1W-TC103, CJ1W-TC104 	<ul style="list-style-type: none"> ■ High-speed Counter Units CJ1W-CT021 ● Position Control Units CJ1W-NC113 CJ1W-NC213 CJ1W-NC413 CJ1W-NC133 CJ1W-NC233 CJ1W-NC433 ■ MECHATROLINK II-compatible Position Control Unit CJ1W-NCF71 ■ MECHATROLINK II-compatible Motion Control Unit CJ1W-MCH71 	<ul style="list-style-type: none"> ■ Serial Communications Units CJ1W-SCU21-V1 CJ1W-SCU31-V1 CJ1W-SCU41-V1 ■ Ethernet Unit CJ1W-ETN21 ■ Controller Link Units CJ1W-CLK21-V1 CJ1W-CLK23 NEW ■ FL-net Unit CJ1W-FLN22 ■ DeviceNet Unit CJ1W-DRM21 ■ CompoNet Master Unit CJ1W-CRM21 ■ CompoBus/S Master Unit CJ1W-SRM21 	<ul style="list-style-type: none"> ■ ID Sensor Units CJ1W-V680C11 NEW CJ1W-V680C12 NEW CJ1W-V600C11 CJ1W-V600C12
			<ul style="list-style-type: none"> ■ High-speed Data Storage Unit CJ1W-SPU01-V2 NEW

■ CJ-series CPU Racks

A CJ-series CPU Rack consists of a CPU Unit, Power Supply Unit, Configuration Units (Basic I/O Units, Special I/O Units, and CPU Bus Units), and an End Cover.

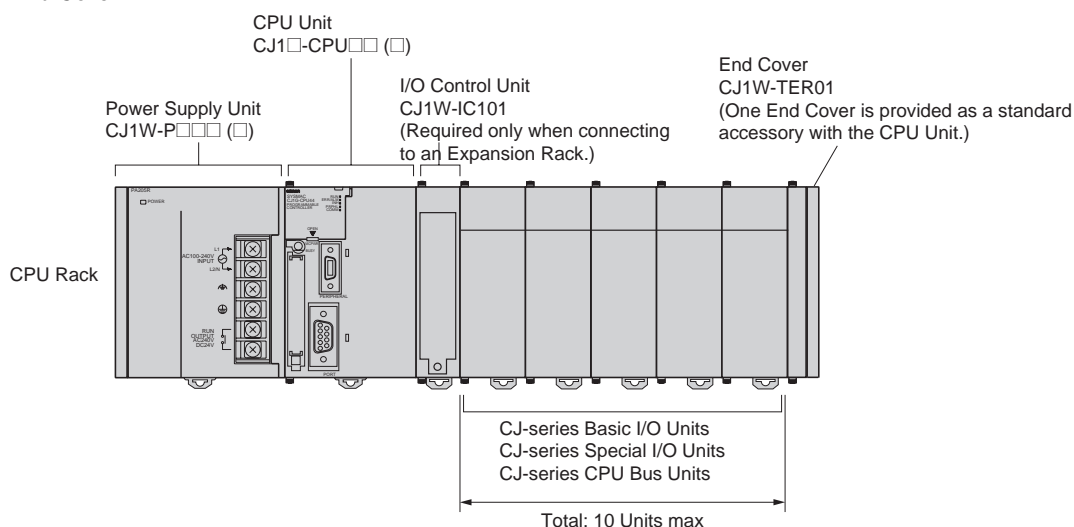

● Required Units

Rack	Unit name	Required number of Units
CPU Rack	Power Supply Unit	1
	CPU Unit	1
	I/O Control Unit	Required only for mounting to an Expansion Rack.
	Number of Configuration Units	10 max. (Same for all models of CPU Unit.) (The number of Basic I/O Units, Special I/O Units, and CPU Bus Units can be varied. The number does not include the I/O Control Unit.)
	End Cover	1 (Included with CPU Unit.)

● Types of Units

In the SYSMAC CJ Series, Units are classified into the following three types. The number of Racks differs depending on the type.

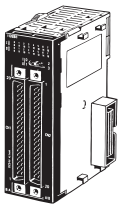
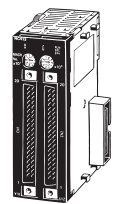
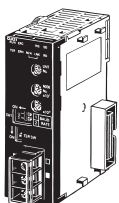
Type	Appearance (example)	Description	Unit recognition method	No. of Units
Basic I/O Units		Basic I/O Units provide up to 128 I/O points, with contact inputs and contact outputs.	Recognized by the CPU Unit according to the position of the Rack and slot.	No restrictions.
Special I/O Units		Special I/O Units provide more advanced functions than do Basic I/O Units, including I/O other than contact inputs and contact outputs. Examples of Special I/O Units are Analog I/O Units and High-speed Counter Units. They differ from CPU Bus Units (including Network Communications Units) in having a smaller area for exchanging data with the CPU Unit.	Recognized by the CPU Unit according to the unit number (0 to 95) set with the rotary switches on the front panel.	A maximum of 96 Units can be connected. (Multiple unit numbers are allocated per Unit, depending on the model and settings.)
CPU Bus Units		CPU Bus Units exchange data with the CPU Unit via the CPU Bus. Examples of CPU Bus Units are Network Communications Units and Serial Communications Units. They differ from Special I/O Units in having a larger area for exchanging data with the CPU Unit.	Recognized by the CPU Unit according to the unit number (0 to F) set with the rotary switch on the front panel.	A maximum of 16 Units can be mounted.

■ CJ-series Expansion Racks

A CJ-series Expansion Rack consists of a Power Supply Unit, an I/O Interface Unit, Configuration Units (Basic I/O Units, Special I/O Units, and CPU Bus Units), and an End Cover.

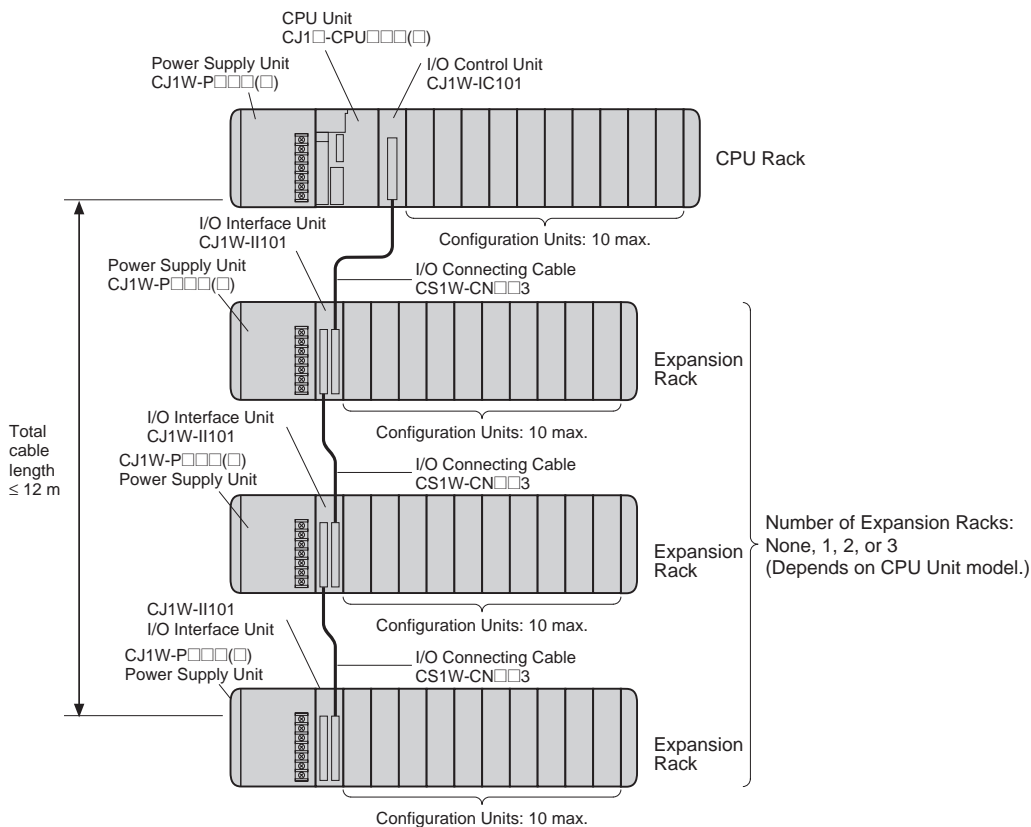

● Required Units

Rack	Unit name	Required number of Units
CPU Rack	I/O Control Unit	One Unit. Required only when an Expansion Rack is used. Mount the I/O Control Unit immediately to the right of the CPU Unit. (See note 1.)
Expansion Rack	Power Supply Unit	One Unit
	I/O Interface Unit	One Unit. Mount the I/O Interface Unit immediately to the right of the Power Supply Unit. (See note 2.)
	Number of Configuration Units	Ten Units max. (The number of Basic I/O Units, Special I/O Units, and CPU Bus Units can be varied. This number does not include the I/O Interface Unit.)
	End Cover	One (Included with the I/O Interface Unit.)

- Note 1.** Mounting the I/O Control Unit in any other location may cause faulty operation.
Note 2. Mounting the I/O Interface Unit in any other location may cause faulty operation.

● Maximum Number of Configuration Units That Can Be Mounted

CPU Unit	Model	Total Units	No. of Units on CPU Rack	No. of Expansion Racks
CJ1H	CJ1H-CPU67H-R/67H	40	10 per Rack	3 Racks x 10 Units
	CJ1H-CPU66H-R/66H			
	CJ1H-CPU65H-R/65H			
	CJ1H-CPU64H-R			
CJ1G	CJ1G-CPU45H/45P (-GTC)	30	10 per Rack	2 Racks x 10 Units
	CJ1G-CPU44H/44P			
	CJ1G-CPU43H/43P			
	CJ1G-CPU42H/42P			
CJ1M	CJ1M-CPU13	20	10 per Rack	1 Rack x 10 Units
	CJ1M-CPU23			
	CJ1M-CPU12	10	10 per Rack	Cannot be connected.
	CJ1M-CPU11			
	CJ1M-CPU22			
	CJ1M-CPU21			

Dimensions

Note: Units are in mm unless specified otherwise.

Product Dimensions

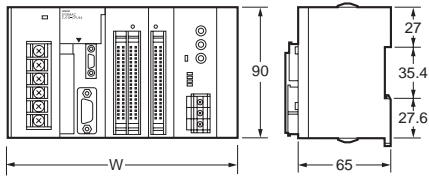

Example Rack Widths using CJ1WPA202 Power Supply Unit (AC, 14 W)

No. of Units mounted with 31-mm width	Rack width (mm)			
	With CJ1M-CPU11/12/13	With CJ1M-CPU21/22/23	With CJ1H-CPU□□H-R, CJ1H-CPU□□H, or CJ1G-CPU□□H	With CJ1G-CPU□□P(-GTC) CPU Unit
1	121.7	139.7	152.7	159.7
2	152.7	170.7	183.7	190.7
3	183.7	201.7	214.7	221.7
4	214.7	232.7	245.7	252.7
5	245.7	263.7	276.7	283.7
6	276.7	294.7	307.7	314.7
7	307.7	325.7	338.7	345.7
8	338.7	356.7	369.7	376.7
9	369.7	387.7	400.7	407.7
10	400.7	418.7	431.7	438.7

Power Supply Units, CPU Units, and End Covers

Unit/product	Model	Width
Power Supply Unit	CJ1W-PA205C	80
	CJ1W-PA205R	80
	CJ1W-PA202	45
	CJ1W-PD025	60
	CJ1W-PD022	27
CPU Unit	CJ1M-CPU1□	31
	CJ1M-CPU2□	49
	CJ1H-CPU□□H-R	62
	CJ1H-CPU□□H	
	CJ1G-CPU□□H	
CJ1G-CPU□□P	69	
End Cover	CJ1W-TER01	14.7

Power Supply Units

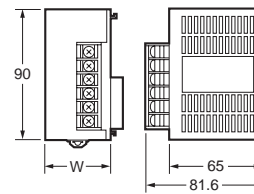

W=27: CJ1W-PD022
 W=45: CJ1W-PA202
 W=80: CJ1W-PA205R
 CJ1W-PA205C
 W=60: CJ1W-PD025

End Cover (included with CPU Units)

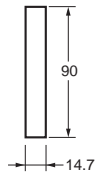

RS-422A Adapter CJ1W-CIF11

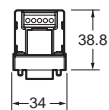

CPU Units

CJ1H-CPU□□H-R
 CJ1H-CPU□□H
 CJ1G-CPU□□H

CJ1G-CPU□□P

CJ1M-CPU11/12/13

CJ1M-CPU21/22/23

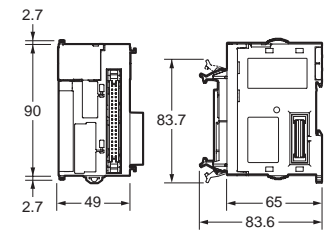
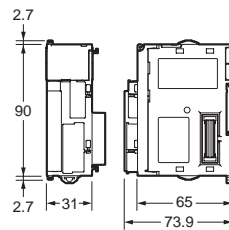
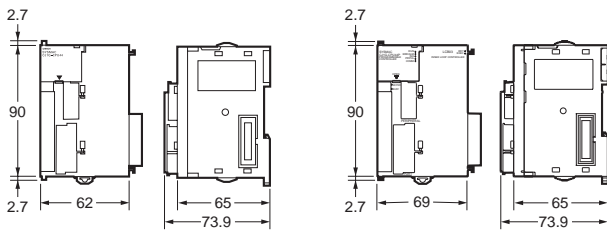

Units of Width 20 mm

Unit/product	Model	Width
I/O Control Unit	CJ1W-IC101	20
32-point Basic I/O Units	CJ1W-ID231/232	
	CJ1W-OD231/232/233	
B7A Interface Unit	CJ1W-B7A22	
	CJ1W-B7A14	
	CJ1W-B7A04	
CompoBus/S Master Unit	CJ1W-SRM21	
Space Unit	CJ1W-SP001	

I/O Control Unit

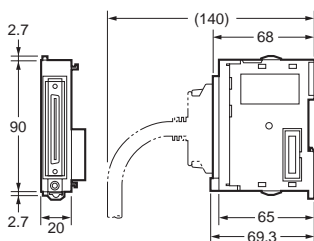

32-Point I/O Units (CJ1W-ID23□/OD23□)

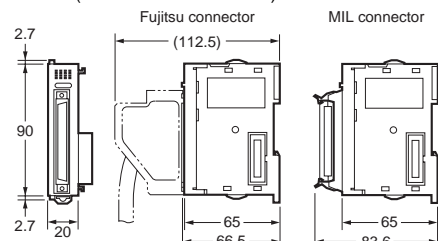

● Units of Width 31 mm

Unit	Model	Width
I/O Interface Unit	CJ1W-II101	31
8/16-point Basic I/O Units	CJ1W-ID201	
	CJ1W-ID211	
	CJ1W-IA111/201	
	CJ1W-OD20□	
	CJ1W-OD211/212	
	CJ1W-OC201/211	
CJ1W-OA201		
32-point Basic I/O Units	CJ1W-MD231	
	CJ1W-MD232/233	
64-point Basic I/O Units	CJ1W-ID261	
	CJ1W-OD261	
	CJ1W-MD261	
	CJ1W-ID262	
Interrupt Input Unit	CJ1W-OD262/263	
	CJ1W-MD263	
	CJ1W-MD563	
	High-speed Input Unit	
High-speed Input Unit	CJ1W-IDP01	
Analog I/O Units	CJ1W-AD□□□□-V1	
	CJ1W-DA□□□□	
	CJ1W-MAD42	
Process Input Units	CJ1W-AD04U	
	CJ1W-PH41U	
	CJ1W-PTS51/52/15/16	
	CJ1W-PDC15	
Temperature Control Units	CJ1W-TC□□□□	
Position Control Units	CJ1W-NC113/133	
	CJ1W-NC213/233	
	CJ1W-NC413/433	
MECHATROLINK-II compatible Position Control Unit	CJ1W-NCF71	
High-speed Counter Unit	CJ1W-CT021	
ID Sensor Units	CJ1W-V680C11	
	CJ1W-V680C12	
	CJ1W-V600C11	
	CJ1W-V600C12	
Controller Link Units	CJ1W-CLK23	
	CJ1W-CLK21-V1	
Serial Communications Units	CJ1W-SCU41-V1	
	CJ1W-SCU21-V1	
	CJ1W-SCU31-V1	
Ethernet Unit	CJ1W-ETN21	
DeviceNet Unit	CJ1W-DRM21	
CompoNet Master Unit	CJ1W-CRM21	
FL-net Unit	CJ1W-FLN22	

● I/O Interface Unit

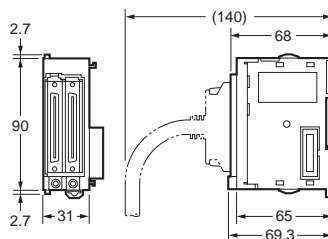

● 8/16-point Basic I/O Units, Interrupt Input Unit, and High-speed Input Unit

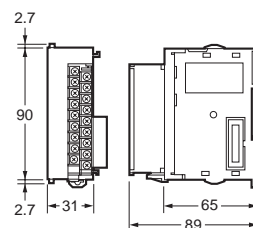

● 64-point Basic I/O Units and 32-point Basic I/O Units (CJ1W-MD23□)

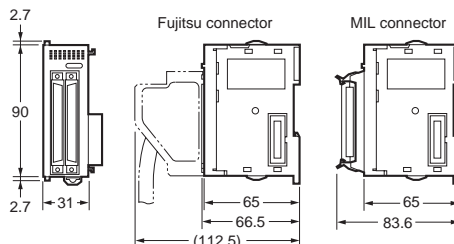

● Special I/O Units and CPU Bus Units

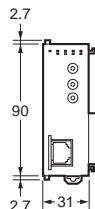

● Unit of Width 51 mm

Unit	Model	Width
SYSMAC SPU (High-speed Data Storage Unit)	CJ1W-SPU01-V2	51

● SYSMAC SPU (High-speed Data Storage Unit) CJ1W-SPU01-V2

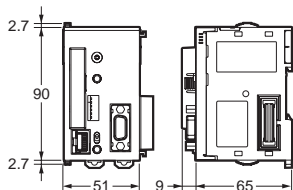

● Unit of Width 79.8 mm

Unit	Model	Width
MECHATROLINK-II compatible Motion Control Unit	CJ1W-MCH71	79.8

● MECHATROLINK-II compatible Motion Control Unit CJ1W-MCH71

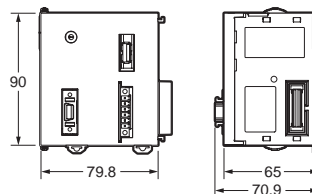

■ Mounting Dimensions



DIN Track model number	A
PFP-100N2	16 mm
PFP-100N	7.3 mm
FPP-50N	7.3 mm

■ Mounting Height

The mounting height of CJ-series CPU Racks and Expansion Racks is from 81.6 to 89.0 mm depending on the Units that are mounted.

Additional height is required to connect Programming Devices (e.g., CX-Programmer or Programming Console) and Cables. Be sure to allow sufficient mounting height.

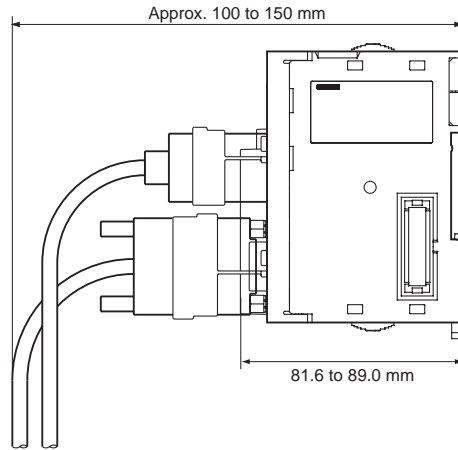

Note: Consider the following points when expanding the configuration:
 The total length of I/O Connecting Cable must not exceed 12 m.
 I/O Connecting Cables require the bending radius indicated below.

● CJ-series Connecting Cable

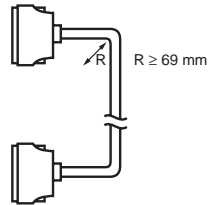

Note: Outer diameter of cable: 8.6 mm.



General Specifications

Item	Specifications				
	CJ1W-PA205R	CJ1W-PA205C	CJ1W-PA202	CJ1W-PD025	CJ1W-PD022
Power Supply Unit					
Supply voltage	100 to 240 V AC (wide-range), 50/60 Hz			24 VDC	
Operating voltage and frequency ranges	85 to 264 V AC, 47 to 63 Hz			19.2 to 28.8 V DC	21.6 to 26.4 V DC
Power consumption	100 VA max.		50 VA max.	50 W max.	35 W max.
Inrush current (See note 1.)	At 100 to 120 V AC: 15 A/8 ms max. for cold start at room temperature At 200 to 240 V AC: 30 A/8 ms max. for cold start at room temperature		At 100 to 120 V AC: 20 A/8 ms max. for cold start at room temperature At 200 to 240 V AC: 40 A/8 ms max. for cold start at room temperature	At 24 V DC: 30 A/20 ms max. for cold start at room temperature	
Output capacity (See note 7.)	5.0 A, 5 V DC (including supply to CPU Unit)		2.8 A, 5 V DC (including supply to CPU Unit)	5.0 A, 5 V DC (including supply to CPU Unit)	2.0 A, 5 V DC (including supply to CPU Unit)
	0.8 A, 24 V DC		0.4 A, 24 V DC	0.8 A, 24 V DC	0.4 A, 24 V DC
	Total: 25 W max.		Total: 14 W max.	Total: 25 W max.	Total: 19.6 W max.
Output terminal (service supply)	Not provided.				
RUN output (See note 2.)	Contact configuration: SPST-NO Switch capacity: 250 V AC, 2 A (resistive load) 120 V AC, 0.5 A (inductive load), 24 V DC, 2A (resistive load) 24 V DC, 2 A (inductive load)	Not provided.			
Replacement notification function	Not provided.	With Alarm output (open-collector output) 30 V DC max., 50 mA max.	Not provided.		
Insulation resistance	20 MΩ min. (at 500 V DC) between AC external and GR terminals (See note 3.)	<ul style="list-style-type: none"> 20 MΩ min. (at 500 V DC) between all external terminals and GR terminal, and between all alarm output terminals. 20 MΩ 1 min. (at 250 V DC) between all alarm output terminals and GR terminal. 	20 MΩ min. (at 500 V DC) between AC external and GR terminals (See note 3.)	20 MΩ min. (at 500 V DC) between DC external and GR terminals (See note 3.)	--- (See note 6.)
Dielectric strength (See note 4.)	2,300 V AC 50/60 Hz for 1 min between AC external and GR terminals (See note 3.) Leakage current: 10 mA max.	<ul style="list-style-type: none"> 2,300 VAC, 50/60 Hz for 1 minute between all external terminals and GR terminal and between all alarm output terminals with a leakage current of 10 mA max. 1,000 V AC, 50/60 Hz for 1 minute between all alarm output terminals and GR terminal with a leakage current of 10 mA max. 	2,300 V AC 50/60 Hz for 1 min between AC external and GR terminals (See note 3.) Leakage current: 10 mA max.	1,000 V AC, 50/60 Hz for 1 minute between DC external and GR terminals (See note 3.) Leakage current: 10 mA max.	--- (See note 6.)
	1,000 V AC, 50/60 Hz for 1 minute between DC external and GR terminals (See note 3.) Leakage current: 10 mA max.				
Noise immunity	2 kV on power supply line (conforming to IEC61000-4-4)				
Vibration resistance	10 to 57 Hz, 0.075-mm amplitude, 57 to 150 Hz, acceleration: 9.8 m/s ² in X, Y, and Z directions for 80 minutes (Time coefficient: 8 minutes × coefficient factor 10 = total time 80 min.) (according to JIS C0040)				
Shock resistance	147 m/s ² 3 times each in X, Y, and Z directions (Relay Output Unit: 100 m/s ²) (according to JIS C0041)				
Ambient operating temperature	0 to 55°C				
Ambient operating humidity	10% to 90% (with no condensation)	10% to 90% (with no condensation) (See note 5.)	10% to 90% (with no condensation)		
Atmosphere	Must be free from corrosive gases.				
Ambient storage temperature	-20 to 70°C (excluding battery)	-20 to 75°C (See note 5.)	-20 to 75°C (excluding battery)		
Grounding	Less than 100 Ω				
Enclosure	Mounted in a panel.				
Weight	All models are each 5 kg max.				

Item	Specifications				
	CJ1W-PA205R	CJ1W-PA205C	CJ1W-PA202	CJ1W-PD025	CJ1W-PD022
Power Supply Unit					
CPU Rack dimensions	90.7 to 466.7 × 90 × 65 mm (W × H × D) (not including cables) Note: $W = a + b + 20 \times n + 31 \times m + 14.7$ a: Power Supply Unit: PA205R and PA205C = 80; PA202 = 45; PD025 = 60; PD022=27 b: CPU Unit: CJ1-H or CJ1 = 62; CJ1M-CPU1□ = 31; CJ1M-CPU2□ = 49 The total width is given by the following: $W = 156.7 + n \times 20 + m \times 31$, where n is the number of 32-point I/O Units or I/O Control Units and m is the number of other Units.				
Safety measures	Conforms to cULus and EC Directives.				

- Note 1.** Disconnect the Power Supply Units LG terminal from the GR terminal when testing insulation and dielectric strength. Testing the insulation and dielectric strength with the LG terminal and the GR terminals connected will damage internal circuits in the CPU Unit.
2. Supported only when mounted to CPU Rack.
 3. The inrush current is given for a cold start at room temperature. The inrush control circuit uses a thermistor element with a low-temperature current control characteristic. If the ambient temperature is high or the PLC is hot-started, the thermistor will not be sufficiently cool, and the inrush currents given in the table may be exceeded by up to twice the given values. When selecting fuses or breakers for external circuits, allow sufficient margin in shut-off performance.
 4. Maintain an ambient storage temperature of -25 to 30°C and relative humidity of 25% to 70% when storing the Unit for longer than 3 months to keep the replacement notification function in optimum working condition.
 5. Change the applied voltage gradually using the adjuster on the Tester. If the full dielectric strength voltage is applied or turned OFF using the switch on the Tester, the generated impulse voltage may damage the Power Supply Unit.
 6. CJ1W-PD022 is not insulated between the primary DC power and secondary DC power.
 7. Internal components in the Power Supply Unit will deteriorate or be damaged if the Power Supply Unit is used for an extended period of time exceeding the power supply output capacity or if the outputs are shorted.

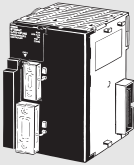
CPU Units

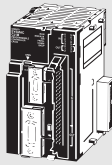
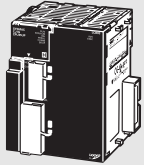
Item	CJ1G/H/H-R CPU Units			CJ1M CPU Units		CJ1G Loop-control CPU Units
	CJ1-H-R CPU Units	CJ1H-H CPU Units	CJ1G-H CPU Units	Without Built-in I/O	With Built-in I/O	
	CJ1H-CPU□□H-R	CJ1H-CPU□□H	CJ1G-CPU□□H	CJ1M-CPU1□	CJ1M-CPU2□	CJ1G-CPU□□P(-GTC)
Appearance						
LD instruction processing speed	0.016 μs	0.02 μs	0.04 μs	0.1 μs	0.1 μs	0.04 μs
Program capacity	250K to 30K steps	250K to 60K steps	60K to 10K steps	20K to 5K steps	20K to 5K steps	60K to 10K steps
Data memory capacity	448K to 64K words	448K to 128K words	128K to 64K words	32K words	32K words	128K to 64K words
I/O bits	2560 bits	2560 bits	1280 to 960 bits	640 to 160 bits	640 to 160 bits	1280 to 960 bits
Width	62 mm	62 mm	62 mm	31 mm	49 mm	69 mm
Built-in I/O	---				16 bits	---
Loop control	---					50 to 300 blocks

Specifications

■ Common Specifications

Item		Specifications	
Control method		Stored program	
I/O control method		Cyclic scan and immediate processing are both possible.	
Programming		Ladder diagram	
CPU processing mode		CJ1-H CPU Units: Normal Mode, Parallel Processing Mode with Asynchronous Memory Access, Parallel Processing Mode with Synchronous Memory Access, or Peripheral Servicing Priority Mode CJ1M CPU Units: Normal Mode or Peripheral Servicing Priority Mode CJ1 CPU Units: Normal Mode or Peripheral Servicing Priority Mode	
Instruction length		1 to 7 steps per instruction	
Ladder instructions		Approx. 400 (3-digit function codes)	
Execution time		<p>CJ1-H-R CPU Units</p> <p>Basic instructions: 0.016 μs min. Special instructions: 0.048 μs min.</p> <p>CJ1-H CPU Units:</p> <p>Basic instructions: 0.02 μs min. Special instructions: 0.06 μs min.</p> <p>CJ1M CPU Units (CPU12/13/22/23):</p> <p>Basic instructions: 0.10 μs min. Special instructions: 0.15 μs min.</p> <p>CJ1M CPU Units (CPU11/21):</p> <p>Basic instructions: 0.10 μs min. Special instructions: 0.15 μs min.</p> <p>CJ1 CPU Units:</p> <p>Basic instructions: 0.08 μs min. Special instructions: 0.12 μs min.</p>	
Overhead time		<p>CJ1-H-R CPU Units:</p> <p>Normal mode: 0.13 ms min. Parallel processing: 0.28 ms min.</p> <p>CJ1-H CPU Units: 0.3 ms min</p> <p>Normal mode: 0.3 ms min. Parallel processing: 0.3 ms min.</p> <p>CJ1M CPU Units (CPU12/13/22/23): 0.5 ms min. CJ1M CPU Units (CPU11/12): 0.7 ms min. CJ1 CPU Units: 0.5 ms min.</p>	
Unit connection method		No Backplane: Units connected directly to each other.	
Mounting method		DIN Track (screw mounting not possible)	
Maximum number of connectable Units		<ul style="list-style-type: none"> • CJ1-H and CJ1 CPU Units: Per CPU or Expansion Rack: 10 Units including Basic I/O Units, Special I/O Units, and CPU Bus Units. Total per PLC: 10 Units on CPU Rack and 10 Units each on 3 Expansion Racks = 40 Units total • CJ1M CPU Units: Total of 20 Units in the System, including 10 Units on CPU Rack and 10 Units on one Expansion Rack. 	
Maximum number of Expansion Racks		<ul style="list-style-type: none"> • CJ1-H and CJ1 CPU Units: 3 max. (An I/O Control Unit is required on the CPU Rack and an I/O Interface Unit is required on each Expansion Rack.) • CJ1M CPU Units (CPU 13/23 only): 1 max. (An I/O Control Unit is required on the CPU Rack and an I/O Interface Unit is required on the Expansion Rack.) • CJ1M CPU Units (CPU11/12/21/22): Expansion is not possible. 	
Number of tasks		<p>288 (cyclic tasks: 32, interrupt tasks: 256)</p> <p>With CJ1-H or CJ1M CPU Units, interrupt tasks can be defined as cyclic tasks called extra cyclic tasks. Including these, up to 288 cyclic tasks can be used.</p> <p>Note 1. Cyclic tasks are executed each cycle and are controlled with TKON(820) and TKOF(821) instructions.</p> <p>2. The following 4 types of interrupt tasks are supported.</p> <p>Power OFF interrupt tasks: 1 max. Scheduled interrupt tasks: 2 max. I/O interrupt tasks: 32 max. External interrupt tasks: 256 max.</p>	
Interrupt types		<p>Scheduled Interrupts: Interrupts generated at a time scheduled by the CPU Units built-in timer. (See note. 1)</p> <p>I/O Interrupts: Interrupts from Interrupt Input Units.</p> <p>Power OFF Interrupts (See note 2.): Interrupts executed when the CPU Units power is turned OFF.</p> <p>External I/O Interrupts: Interrupts from the Special I/O Units or CPU Bus Units.</p> <p>Note 1. CJ1-H and CJ1 CPU Units: Scheduled interrupt time interval is either 1 ms to 9,999 ms or 10 ms to 99,990 ms, in units of 1 ms or 10 ms. CJ1M CPU Units: In addition to the above, a scheduled interrupt time interval of 0.5 ms to 999.9 ms, in units of 0.1 ms, is also possible.</p> <p>2. Not supported when the CJ1W-PD022 Power Supply Unit is mounted.</p>	
Calling subroutines from more than one task		<ul style="list-style-type: none"> • CJ1-H CPU Units: Supported (called global subroutines). • CJ1 CPU Units: Not supported. 	
CIO (Core I/O) Area	I/O Area	2,560: CIO 000000 to CIO 015915 (160 words from CIO 0000 to CIO 0159) The setting of the first word can be changed from the default (CIO 0000) so that CIO 0000 to CIO 0999 can be used. I/O bits are allocated to Basic I/O Units.	The CIO Area can be used as work bits if the bits are not used as shown here.
	Link Area	3,200 (200 words): CIO 10000 to CIO 119915 (words CIO 1000 to CIO 1199) Link bits are used for data links and are allocated to Units in Controller Link Systems.	

Item	Specifications												
CIO (Core I/O) Area	CPU Bus Unit Area 6,400 (400 words): CIO 150000 to CIO 189915 (words CIO 1500 to CIO 1899) CPU Bus Unit bits store the operating status of CPU Bus Units. (25 words per Unit, 16 Units max.)												
	Special I/O Unit Area 15,360 (960 words): CIO 200000 to CIO 295915 (words CIO 2000 to CIO 2959) Special I/O Unit bits are allocated to Special I/O Units. (10 words per Unit, 96 Units max.)												
	Serial PLC Link Area (CJ1M CPU Units only) 1,440 (90 words): CIO 310000 to CIO 318915 (words CIO 3100 to CIO 3189)												
	DeviceNet Area 9,600 (600 words): CIO 320000 to CIO 379915 (words CIO 3200 to CIO 3799) DeviceNet bits are allocated to Slaves for DeviceNet Unit remote I/O communications when the Master function is used with fixed allocations. <table border="1" data-bbox="512 459 1115 624"> <tr> <td>Fixed allocation setting 1</td> <td>Outputs: CIO 3200 to CIO 3263 Inputs: CIO 3300 to CIO 3363</td> </tr> <tr> <td>Fixed allocation setting 2</td> <td>Outputs: CIO 3400 to CIO 3463 Inputs: CIO 3500 to CIO 3563</td> </tr> <tr> <td>Fixed allocation setting 3</td> <td>Outputs: CIO 3600 to CIO 3663 Inputs: CIO 3700 to CIO 3763</td> </tr> </table> The following words are allocated to the Master function even when the DeviceNet Unit is used as a Slave. <table border="1" data-bbox="512 689 1115 855"> <tr> <td>Fixed allocation setting 1</td> <td>Outputs: CIO 3370 (Slave to Master) Inputs: CIO 3270 (Master to Slave)</td> </tr> <tr> <td>Fixed allocation setting 2</td> <td>Outputs: CIO 3570 (Slave to Master) Inputs: CIO 3470 (Master to Slave)</td> </tr> <tr> <td>Fixed allocation setting 3</td> <td>Outputs: CIO 3770 (Slave to Master) Inputs: CIO 3670 (Master to Slave)</td> </tr> </table>	Fixed allocation setting 1	Outputs: CIO 3200 to CIO 3263 Inputs: CIO 3300 to CIO 3363	Fixed allocation setting 2	Outputs: CIO 3400 to CIO 3463 Inputs: CIO 3500 to CIO 3563	Fixed allocation setting 3	Outputs: CIO 3600 to CIO 3663 Inputs: CIO 3700 to CIO 3763	Fixed allocation setting 1	Outputs: CIO 3370 (Slave to Master) Inputs: CIO 3270 (Master to Slave)	Fixed allocation setting 2	Outputs: CIO 3570 (Slave to Master) Inputs: CIO 3470 (Master to Slave)	Fixed allocation setting 3	Outputs: CIO 3770 (Slave to Master) Inputs: CIO 3670 (Master to Slave)
	Fixed allocation setting 1	Outputs: CIO 3200 to CIO 3263 Inputs: CIO 3300 to CIO 3363											
Fixed allocation setting 2	Outputs: CIO 3400 to CIO 3463 Inputs: CIO 3500 to CIO 3563												
Fixed allocation setting 3	Outputs: CIO 3600 to CIO 3663 Inputs: CIO 3700 to CIO 3763												
Fixed allocation setting 1	Outputs: CIO 3370 (Slave to Master) Inputs: CIO 3270 (Master to Slave)												
Fixed allocation setting 2	Outputs: CIO 3570 (Slave to Master) Inputs: CIO 3470 (Master to Slave)												
Fixed allocation setting 3	Outputs: CIO 3770 (Slave to Master) Inputs: CIO 3670 (Master to Slave)												
Internal I/O Area 4,800 (300 words): CIO 120000 to CIO 149915 (words CIO 1200 to CIO 1499) 37,504 (2,344 words): CIO 380000 to CIO 614315 (words CIO 3800 CIO 6143) These bits in the CIO Area are used as work bits in programming to control program execution. They cannot be used for external I/O.													
Work Area	8,192 bits (512 words): W00000 to W51115 (W000 to W511) Controls the programs only. (I/O from external I/O terminals is not possible.) Note: When using work bits in programming, use the bits in the Work Area first before using bits from other areas.												
Holding Area	8,192 bits (512 words): H00000 to H51115 (H000 to H511) Holding bits are used to control the execution of the program, and maintain their ON/OFF status when the PLC is turned OFF or the operating mode is changed. Note: The Function Block Holding Area words are allocated from H512 to H1535. These words can be used only for the function block instance area (internally allocated variable area).												
Auxiliary Area	Read only: 7,168 bits (448 words): A00000 to A44715 (words A000 to A447) Read/write: 8,192 bits (512 words): A44800 to A95915 (words A448 to A959) Auxiliary bits are allocated specific functions.												
Temporary Area	16 bits (TR0 to TR15) Temporary bits are used to temporarily store the ON/OFF execution conditions at program branches.												
Timer Area	4,096: T0000 to T4095 (used for timers only)												
Counter Area	4,096: C0000 to C4095 (used for counters only)												
DM Area	32 Kwords: D00000 to D32767 Used as a general-purpose data area for reading and writing data in word units (16 bits). Words in the DM Area maintain their status when the PLC is turned OFF or the operating mode is changed. Internal Special I/O Unit DM Area: D20000 to D29599 (100 words × 96 Units) Used to set parameters for Special I/O Units. CPU Bus Unit DM Area: D30000 to D31599 (100 words × 16 Units) Used to set parameters for CPU Bus Units.												
EM Area (CJ1-H and CJ1 CPU Units only)	32 Kwords per bank, 7 banks max.: E0_00000 to E6_32767 max. (depending on model of CPU Unit) Used as a general-purpose data area for reading and writing data in word units (16 bits). Words in the EM Area maintain their status when the PLC is turned OFF or the operating mode is changed. The EM Area is divided into banks, and the addresses can be set by either of the following methods. Changing the current bank using the EMBC(281) instruction and setting addresses for the current bank. Setting bank numbers and addresses directly. EM data can be stored in files by specifying the number of the first bank.												
Index Registers	IR0 to IR15 Store PLC memory addresses for indirect addressing. Index registers can be used independently in each task. One register is 32 bits (2 words). <ul style="list-style-type: none"> • CJ1-H and CJ1M CPU Units: Setting to use index registers either independently in each task or to share them between tasks. • CJ1 CPU Units: Index registers used independently in each task. 												
Task Flag Area	32 (TK0000 to TK0031) Task Flags are read-only flags that are ON when the corresponding cyclic task is executable and OFF when the corresponding task is not executable or in standby status.												
Trace Memory	4,000 words (trace data: 31 bits, 6 words)												
File Memory	<ul style="list-style-type: none"> • Memory Cards: Compact flash memory cards can be used (MS-DOS format). • EM file memory (CJ1-H and CJ1 CPU Units only): Part of the EM Area can be converted to file memory (MS-DOS format). • OMRON Memory Cards can be used. 												

The CIO Area can be used as work bits if the bits are not used as shown here.

■ Function Specifications

Item	Specifications	
Constant cycle time	1 to 32,000 ms (Unit: 1 ms) Note: When a Parallel Processing Mode is used for a CJ1-H CPU Unit, the cycle time for executing instructions is constant.	
Cycle time monitoring	Possible (Unit stops operating if the cycle is too long): 10 to 40,000 ms (Unit: 10 ms) Note: When a Parallel Processing Mode is used for a CJ1-H CPU Unit, the instruction execution cycle is monitored. CPU Unit operation will stop if the peripheral servicing cycle time exceeds 2 s (fixed).	
I/O refreshing	Cyclic refreshing, immediate refreshing, refreshing by IORF(097). Note: ORF(097) refreshes I/O bits allocated to Basic I/O Units and Special I/O Units. With the CJ1-H and CJ1M CPU Units, the CPU BUS UNIT I/O REFRESH (DLNK(226)) instruction can be used to refresh bits allocated to CPU Bus Units in the CIO and DM Areas.	
Timing of special refreshing for CPU Bus Units	Data links for Controller Link Units and SYSMAC LINK Units, remote I/O for DeviceNet Units, and other special refreshing for CPU Bus Units is performed at the following times: <ul style="list-style-type: none"> • CJ1 and CJ1M CPU Units: I/O refresh period • CJ1-H CPU Units: I/O refresh period and when the CPU BUS UNIT I/O REFRESH (DLNK(226)) instruction is executed. 	
I/O memory holding when changing operating modes	Depends on the ON/OFF status of the IOM Hold Bit in the Auxiliary Area.	
Load OFF	All outputs on Output Units can be turned OFF when the CPU Unit is operating in RUN, MONITOR, or PROGRAM mode.	
Timer/Counter PV refresh method	CJ1-H and CJ1M CPU Units: BCD or binary (CX-Programmer Ver. 3.0 or higher). CJ1 CPU Units: BCD only.	
Input response time setting	Time constants can be set for inputs from Basic I/O Units. The time constant can be increased to reduce the influence of noise and chattering or it can be decreased to detect shorter pulses on the inputs.	
Mode setting at power-up	Possible. Note: By default, the CPU Unit will start in RUN mode if a Programming Console is not connected.	
Flash memory (CJ1-H and CJ1M CPU Units only)	<ul style="list-style-type: none"> • The user program and parameter area data (e.g., PLC Setup) are always backed up automatically in flash memory. (automatic backup and restore.) • CPU Units with unit version 3.0 or later only: When downloading projects from CX-Programmer Ver. 5.0 or higher, symbol table files (including CX-Programmer symbol names, I/O comments), comment files (CX-Programmer rung comments, other comments), and program index files (CXProgrammer section names, section comments, or program comments) are stored in comment memory within the flash memory. 	
Memory Card functions	Automatically reading programs (autoboot) from the Memory Card when the power is turned ON.	Possible.
	Program replacement during PLC operation	Possible.
	Format in which data is stored in Memory Card	User program: Program file format PLC Setup and other parameters: Data file format I/O memory: Data file format (binary format), text format, or CSV format
	Functions for which Memory Card read/write is supported	User program instructions, Programming Devices (including CX-Programmer and Programming Consoles), Host Link computers, AR Area control bits, easy backup operation
Filing	Memory Card data and the EM (Extended Data Memory) Area can be handled as files.	
Debugging	Control set/reset, differential monitoring, data tracing (scheduled, each cycle, or when instruction is executed), instruction error tracing, storing location generating error when a program error occurs.	
Online editing	User programs can be overwritten in program-block units when the CPU Unit is in MONITOR or PROGRAM mode. This function is not available for block programming areas. With the CX-Programmer, more than one program block can be edited at the same time.	
Program protection	Overwrite protection: Set using DIP switch. Copy protection: Password set using CX-Programmer or Programming Consoles.	
Error check	User-defined errors (i.e., user can define fatal errors and non-fatal errors) The FPD(269) instruction can be used to check the execution time and logic of each programming block. Note: FAL and FALS instructions can be used with the CJ1-H and CJ1M CPU Units to simulate errors.	
Error log	Up to 20 errors are stored in the error log. Information includes the error code, error details, and the time the error occurred. Note: A CJ1-H or CJ1M CPU Unit can be set so that user-defined FAL errors are not stored in the error log.	
Serial communications	Built-in peripheral port: Programming Device (including Programming Console) connections, Host Links, NT Links Built-in RS-232C port: Programming Device (excluding Programming Console) connections, Host Links, no-protocol communications, NT Links	
	Serial Communications Unit (sold separately): Protocol macros, Host Links, NT Links	
Clock	Provided on all models.	
	Accuracy: Ambient temperature Monthly error	
	55°C -3.5 min to +0.5 min	
	25°C -1.5 min to +1.5 min	
0°C -3 min to +1 min		
Note: Used to store the time when power is turned ON and when errors occur.		
Power OFF detection time	AC Power Supply Unit: 10 to 25 ms (not fixed) DC Power Supply Unit PD025: 2 to 5 ms; PD022: 2 to 10 ms	
Power OFF detection delay time	0 to 10 ms (user-defined, default: 0 ms) Note: Not supported when the CJ1W-PD022 Power Supply Unit is mounted.	
Memory protection	Held Areas: Holding bits, contents of Data Memory and Extended Data Memory, and status of the counter Completion Flags and present values. Note: If the IOM Hold Bit in the Auxiliary Area is turned ON, and the PLC Setup is set to maintain the IOM Hold Bit status when power to the PLC is turned ON, the contents of the CIO Area, the Work Area, part of the Auxiliary Area, timer Completion Flag and PVs, Index Registers, and the Data Registers will be saved for up to 20 days.	
Sending commands to a Host Link computer	FINS commands can be sent to a computer connected via the Host Link System by executing Network Communications Instructions from the PLC.	

Item	Specifications
Remote programming and monitoring	Host Link communications can be used for remote programming and remote monitoring through a Controller Link System or Ethernet network.
Communicating across network levels	Remote programming and monitoring from Support Software and FINS message communications can be performed across different network levels, even for different types of network. Pre-Ver. 2.0: Three levels Version 2.0 or later: Eight levels for Controller Link and Ethernet networks (See note.), three levels for other networks. Note: To communicate across eight levels, the CX-Integrator or the CX-Net in Programmer version 4.0 or higher must be used to set the routing tables.
Storing comments in CPU Unit	I/O comments can be stored as symbol table files in the Memory Card, EM file memory, or comment memory (see note). Note: Comment memory is supported for CX-Programmer version 5.0 or higher and CS/CJ-series CPU Units with unit version 3.0 or later only.
Program check	Program checks are performed at the beginning of operation for items such as no END instruction and instruction errors. CX-Programmer can also be used to check programs.
Control output signals	RUN output: The internal contacts will turn ON (close) while the CPU Unit is operating (CJ1W-PA205R).
Battery life	<ul style="list-style-type: none"> • Battery Set for CJ1-H and CJ1 CPU Units: CPM2A-BAT01 • Battery Set for CJ1M CPU Units: CJ1W-BAT01
Self-diagnostics	CPU errors (watchdog timer), I/O bus errors, memory errors, and battery errors.
Other functions	Storage of number of times power has been interrupted. (Stored in A514.)

● **Functions Added for New Unit Versions**

Refer to the datasheet (Cat. No. P504).

● **Relations between CX-Programmer Versions and Unit Versions of CPU Units**

Refer to the datasheet (Cat. No. P504).

Additional CJ1M-CPU21/22/23 Specifications

- CJ1M-CPU2□ CPU Units have 10 built-in inputs and 6 built-in outputs.
- The 10 inputs can be used as general-purpose inputs, interrupt inputs, quick-response inputs, high-speed counters, or origin search origin input signals.
- The 6 outputs can be used as general-purpose outputs, pulse outputs, or origin search deviation counter reset outputs.

■ Data Area Allocations for Built-in I/O

I/O Code		IN 0	IN 1	IN 2	IN 3	IN 4	IN 5	IN 6	IN 7	IN 8	IN 9	OUT 0	OUT 1	OUT 2	OUT 3	OUT 4	OUT 5
Address		2960										2961					
Bit		0	1	2	3	4	5	6	7	8	9	0	1	2	3	4	5
Inputs	General purpose inputs	General purpose input 0	General purpose input 1	General purpose input 2	General purpose input 3	General purpose input 4	General purpose input 5	General purpose input 6	General purpose input 7	General purpose input 8	General purpose input 9	---	---	---	---	---	---
	Interrupt inputs	Interrupt input 0	Interrupt input 1	Interrupt input 2	Interrupt input 3	---	---	---	---	---	---	---	---	---	---	---	---
	Quick response inputs	Quick response input 0	Quick response input 1	Quick response input 2	Quick response input 3	---	---	---	---	---	---	---	---	---	---	---	---
	Highspeed counters	---	---	High-speed counter 1 (phase-Z/reset)	High-speed counter 0 (phase-Z/reset)	---	---	High-speed counter 1 (phase-A, increment, or count input)	High-speed counter 0 (phase-B, decrement, or direction input)	High-speed counter 0 (phase-A, increment, or count input)	High-speed counter 0 (phase-B, decrement, or direction input)	---	---	---	---	---	---
Out-puts	General-purpose outputs		---	---	---	---	---	---	---	---	---	General-purpose output 0	General-purpose output 1	General-purpose output 2	General-purpose output 3	General-purpose output 4	General-purpose output 5
	Pulse out-puts	CW/CCW outputs	---	---	---	---	---	---	---	---	---	Pulse output 0 (CW)	Pulse output 0 (CCW)	Pulse output 1 (CW)	Pulse output 1 (CCW)	---	---
		Pulse + direction outputs	---	---	---	---	---	---	---	---	---	Pulse output 0 (pulse)	Pulse output 1 (pulse)	Pulse output 0 (direction)	Pulse output 1 (direction)	---	---
		Variable duty ratio outputs	---	---	---	---	---	---	---	---	---	---	---	---	---	---	PWM(891) output 0
Origin search		Origin search 0 (Origin Input Signal)	Origin search 0 (Origin Proximity Input Signal)	Origin search 1 (Origin Input Signal)	Origin search 1 (Origin Proximity Input Signal)	Origin search 0 (Positioning Completed Signal)	Origin search 1 (Positioning Completed Signal)	---	---	---	---	---	---	---	---	Origin search 0 (Error Counter Reset Output)	Origin search 1 (Error Counter Reset Output)

Note: CJ1M-CPU21 CPU Units have one PWM output only and do not have PWM output 1.

■ Built-in Input Specifications

● Interrupt Inputs and Quick-response Inputs

Item	Specifications	
No. of interrupt inputs/quick-response inputs	4 total	
Input inter-rupts	Direct (Input Interrupt) Mode	Execution of an interrupt task is started at the interrupt input's rising or falling edge. Interrupt numbers 140 to 143 are used (fixed). Response time from meeting input condition to start of interrupt task execution: 93 μs min.
	High-speed Counter Mode	Rising or falling edges of the interrupt are counted using either an incrementing or decrementing counter, and an interrupt task is started when the input count reaches the set value. Interrupt numbers 140 to 143 are used (fixed). I/O response frequency: 1 kHz
Quick-response inputs	Signals that are shorter than the cycle time (30 μs min.) can be read and treated the same as signals that are one for more than one cycle time.	

● High-speed Counter Inputs

Item	Specifications				
Number of high-speed counters	2 (High-speed counters 0 and 1)				
Pulse input mode (Selected in PLC Setup)	Differential phase inputs (phase-A, phase-B, and phase-Z input) Up/down inputs (up inputs, down inputs, reset inputs) Pulse + direction inputs (pulse inputs, direction inputs, reset inputs) Increment inputs (increment inputs, reset inputs)				
Re-sponse frequency	Line-driver inputs	50 kHz	100 kHz	100 kHz	100 kHz
	24-V DC inputs	30 kHz	60 kHz	60 kHz	60 kHz
Counting mode	Linear mode or Ring mode (Select in the PLC Setup.)				

Item	Specifications	
Count value	Linear mode: 80000000 to 7FFFFFFF hex Ring mode: 00000000 to Ring SV (The Ring SV is set in the PLC Setup and the setting range is 00000001 to FFFFFFFF hex.)	
High-speed counter PV storage locations	High-speed counter 0: A271 (leftmost 4 digits) and A270 (rightmost 4 digits) High-speed counter 1: A273 (leftmost 4 digits) and A272 (rightmost 4 digits) Target value comparison interrupts or range comparison interrupts can be executed based on these PVs. Note: The PVs are refreshed in the overseeing processes at the beginning of each cycle. Use the PRV(881) instruction to read the most recent PVs.	
Control method	Target value comparison	Up to 48 target values and corresponding interrupt task numbers can be registered.
	Range comparison	Up to 8 ranges can be registered, with an upper limit, lower limit, and interrupt task number for each.
Counter reset method	Phase-Z + Software reset: Counter is reset when phase-Z input goes ON while Reset Bit is ON. Software reset: Counter is reset when Reset Bit goes ON. Reset Bits: High-speed Counter 0 Reset Bit is A53100, Counter 1 Reset Bit is A53101.	

■ Built-in Output Specifications

● Position Control and Speed Control

Item	Specifications
Number of pulse outputs	2 (Pulse output 0 or 1)
Output frequency	1 Hz to 100 kHz (1-Hz units from 1 to 100 Hz, 10-Hz units from 100 Hz to 4 kHz, and 100-Hz units from 4 to 100 kHz)
Frequency acceleration and deceleration rates	Set in 1 Hz units for acceleration/deceleration rates from 1 Hz to 2 kHz (every 4 ms). The acceleration and deceleration rates can be set separately only with PLS2(887).
Changing SVs during instruction execution	The target frequency, acceleration/deceleration rate, and target position can be changed. Changes to the target frequency and acceleration/deceleration rate must be made at constant speed.
Pulse output method	CW/CCW inputs or Pulse + direction inputs
Number of output pulses	Relative coordinates: 00000000 to 7FFFFFFF hex (Each direction accelerating or decelerating: 2,147,483,647) Absolute coordinates: 80000000 to 7FFFFFFF hex (-2,147,483,648 to 2,147,483,647)
Instruction used for origin searches and returns	ORIGIN SEARCH (ORG(889)): Origin search and origin return operations according to set parameters
Instructions used for position and speed control	PULSE OUTPUT (PLS2(887)): Trapezoidal output control with separate acceleration and deceleration rate SET PULSES (PULS(886)): Setting the number of pulses for pulse output SPEED OUTPUT (SPED(885)): Pulse output without acceleration or deceleration (Number of pulses must be set in advance with PULS(886) for position control.) ACCELERATION CONTROL (ACC(888)): Changes frequency or pulse output with acceleration and deceleration MODE CONTROL (INI(880)): Stopping pulse output
Pulse output PV's storage location	The following Auxiliary Area words contain the pulse output PVs: Pulse output 0: A277 (leftmost 4 digits) and A276 (rightmost 4 digits) Pulse output 1: A279 (leftmost 4 digits) and A278 (rightmost 4 digits) The PVs are refreshed during regular I/O refreshing. PVs can be read to user-specified words with the PRV(881) instruction.

● Variable-duty Pulse Outputs (PWM)

Item	Specifications
Number of PWM outputs	CJ1M-CPU22/23: 2 (PWM output 0 or 1) CJ1M-CPU21: 1 (PWM output 0)
Duty ratio	0% to 100%, set in 0.1% units (See note.)
Frequency	0.1 Hz to 999.9 Hz, Set in 0.1 Hz units.
Instruction	PULSE WITH VARIABLE DUTY RATIO (PWM(891)): Sets duty ratio and outputs pulses.

Note: CJ1M CPU Unit Ver. 2.0 or later only. (0% to 100%, set in 1% units for Pre-Ver. 2.0 CPU Units.)

■ Hardware Specifications
● Input Specifications

Item	Specifications			
Number of inputs	10 inputs			
Input method	24-V DC inputs or line driver (wiring changed to select)			
Input voltage specifications	24 V DC		Line driver	
	IN0 to IN5	IN6 to IN9	IN0 to IN5	IN6 to IN9
Input voltage	20.4 to 26.4 V DCV		RS-422A or RS-422 line driver (conforming to AM26LS31), Power supply voltage of 5 V ± 5%	
Input impedance	3.6 kΩ	4.0 kΩ	---	
Input current (typical)	6.2 mA	4.1 mA	13 mA	10 mA
Minimum ON voltage	17.4 V DC/3 mA min.		---	
Maximum OFF voltage	5.0 V DC/1 mA max.		---	
Response speed (for general-purpose inputs)	ON response time	Default setting: 8 ms max. (The input time constant can be set to 0 ms, 0.5 ms, 1 ms, 2 ms, 4 ms, 8 ms, 16 ms, or 32 ms in the PLC Setup.)		
	OFF response time	Default setting: 8 ms max. (The input time constant can be set to 0 ms, 0.5 ms, 1 ms, 2 ms, 4 ms, 8 ms, 16 ms, or 32 ms in the PLC Setup.)		

● Input Circuit Configuration

Item	Specifications	
Input	IN0 to IN5	IN6 to IN9
Circuit configuration		

● General-purpose Output Specifications for Transistor Outputs (Sinking)

Item	Specifications	
Output	OUT0 to OUT3	OUT4 to OUT5
Rated voltage	5 to 24 V DC	
Allowable voltage range	4.75 to 26.4 V DC	
Max. switching capacity	0.3 A/output; 1.8 A/Unit	
Number of circuits	6 outputs (6 outputs/common)	
Max. inrush current	3.0 A/output, 10 ms max.	
Leakage current	0.1 mA max.	
Residual voltage	0.6 V max.	
ON delay	0.1 mA max.	
OFF delay	0.1 mA max.	
Fuse	None	
External power supply	10.2 to 26.4 V DC 50 mA min.	
Circuit configuration		

● Pulse Output Specifications (OUT0 to OUT3)

Item	Specifications
Max. switching capacity	30 mA, 4.75 to 26.4 V DC
Min. switching capacity	7 mA, 4.75 to 26.4 V DC
Max. output frequency	100 kHz
Output waveform	

CJ1G-CPU□□P (Loop-control CPU Units) Specifications

In addition to engines for executing sequence control, Loop-control CPU Units (CJ1G-CPU□□P) have built-in engines for controlling analog quantities (such as temperatures, pressure and flow rate), thus enabling high-speed sequence control and advanced high-speed control of analog quantities in a single Unit.

● CPU Element (Sequence Control)

Name	I/O bits	Program capacity	DM words	EM words	Model
Loop-control CPU Unit	1,280 bits	60K steps	32K words	32K words × 3 banks E0_00000 to E2_32767	CJ1G-CPU45P
		30K steps			CJ1G-CPU45P-GTC (See note.)
		20K steps			CJ1G-CPU44P
	960 bits	20K steps		32K words × 1 bank E0_00000 to E0_32767	CJ1G-CPU43P
		20K steps			CJ1G-CPU42P

Note: These Loop-control CPU Units support gradient temperature control, a technology for uniform in-plane control of temperatures of plane-shaped objects (e.g., multi-point control of surface temperatures based on a multi-point heater). For details, please contact an OMRON representative.

● Loop Controller Element (Loop Control)

Item	Model	CJ1G-CPU42P	CJ1G-CPU43P	CJ1G-CPU44P	CJ1G-CPU45P(-GTC)	
Operation method		Function block method				
Operation cycle		0.01, 0.02, 0.05, 0.1, 0.2, 0.5, 1, or 2 s (default: 1 s) Can be set for each function block.				
Number of function blocks	Analog operations	Control and operation blocks	50 blocks max.	300 blocks max.		
	Sequence control	Step ladder program blocks	20 blocks max. 2,000 commands total	200 blocks max. 4,000 commands total		
	I/O blocks	Field terminal blocks	30 blocks max.		40 blocks max.	
		User link tables	2,400 data items max.			
		Batch allocation	HMI function, allocated 1 EM Area bank			
System Common block		Single block				
Method for creating and transferring function blocks		Created using CX-Process Tool (order separately) and transferred to Loop Controller.				
Control method	PID control method		PID with 2 degrees of freedom (with autotuning)			
	Control combinations		Any of the following function blocks can be combined: Basic PID control, cascade control, feed-forward control, sample PI control, Smith dead time compensation control, PID control with differential gap, override control, program control, time-proportional control, etc.			
Alarms	PID block internal alarms		4 PV alarms (upper upper-limit, upper limit, lower limit, lower lower-limit) and 1 deviation alarm per PID block.			
	Alarm blocks		High/low alarm blocks, deviation alarm blocks			

Checking Current Consumption and Power Consumption

After selecting a Power Supply Unit based on considerations such as the power supply voltage, calculate the current and power requirements for each Rack.

Condition 1: Current Requirements

There are two voltage groups for internal power consumption: 5 V and 24 V.

Current consumption at 5 V (internal logic power supply)

Current consumption at 24 V (relay driving power supply)

Condition 2: Power Requirements

For each Rack, the upper limits are determined for the current and power that can be provided to the mounted Units. Design the system so that the total current consumption for all the mounted Units does not exceed the maximum total power or the maximum current supplied for the voltage groups shown in the following tables.

The maximum current and total power supplied for CPU Racks and Expansion Racks according to the Power Supply Unit model are shown below.

Note 1. For CPU Racks, include the CPU Unit current and power consumption in the calculations. When expanding, also include the current and power consumption of the I/O Control Unit in the calculations.

2. For Expansion Racks, include the I/O Interface Unit current and power consumption in the calculations.

Power Supply Units	Max. current supplied		Max. total power supplied
	5 V	24 V (relay driving current)	
CJ1W-PA205C	5.0 A	0.8 A	25 W
CJ1W-PA205R	5.0 A	0.8 A	25 W
CJ1W-PA202	2.8 A	0.4 A	14 W
CJ1W-PD025	5.0 A	0.8 A	25 W
CJ1W-PD022	2.0 A	0.4 A	19.6 W

Conditions 1 and 2 below must be satisfied.

Condition 1: Maximum Current

- (1) Total Unit current consumption at 5 V ≤ (A) value
- (2) Total Unit current consumption at 24 V ≤ (B) value

Condition 2: Maximum Power

- (1) × 5 V + (2) × 24 V ≤ (C) value

Example: Calculating Total Current and Power Consumption

Example: When the Following Units are Mounted to a CJ-series CPU Rack Using a CJ1W-PA202 Power Supply Unit

Unit type	Model	Quantity	Voltage group	
			5 V	24 V
CPU Unit	CJ1G-CPU45H	1	0.910 A	---
I/O Control Unit	CJ1W-IC101	1	0.020 A	---
Basic I/O Units (Input Units)	CJ1W-ID211	2	0.080 A	---
	CJ1W-ID231	2	0.090 A	---
Basic I/O Units (Output Units)	CJ1W-OC201	2	0.090 A	0.048 A
Special I/O Unit	CJ1W-DA041	1	0.120 A	---
CPU Bus Unit	CJ1W-CLK23	1	0.350 A	---
Current consumption	Total		$0.910 + 0.020 + 0.080 \times 2 + 0.090 \times 2 + 0.090 \times 2 + 0.120 + 0.350$	$0.048 \text{ A} \times 2$
	Result		1.92 A (≤ 2.8 A)	0.096 A (≤ 0.4 A)
Power consumption	Total		$1.92 \times 5 \text{ V} = 9.60 \text{ W}$	$0.096 \text{ A} \times 24 \text{ V} = 2.304 \text{ W}$
	Result		$9.60 + 2.304 = 11.904 \text{ W} (\leq 14 \text{ W})$	

Note: For details on Unit current consumption, refer to *Ordering Information*.

Using the CX-Programmer to Display Current Consumption and Width

CPU Rack and Expansion Rack current consumption and width can be displayed by selecting Current Consumption and Width from the Options Menu in the CS/CJ/CP Table Window. (The width can be displayed for the CJ/CP Series only.) If the capacity of the Power Supply Unit is exceeded, it will be displayed in red characters. For details, refer to the *CX-Programmer Operation Manual* (Cat. No. W446).

Example:

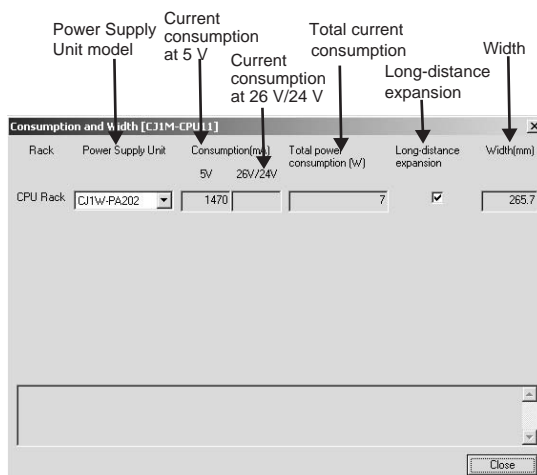

Ordering Information

Basic Configuration Units	38
Programming Devices.....	42
Optional Products and Maintenance Products	45
DIN Track Accessories	45
Basic I/O Units	46
Special I/O Units and CPU Bus Units	50

International Standards

- The standards indicated in the "Standards" column are those current for UL, CSA, cULus, cUL, NK, and Lloyd standards and EC Directives as of the end of January 2008. The standards are abbreviated as follows: U: UL, U1: UL Class 1 Division 2 Products for Hazardous Locations, C: CSA, UC: cULus, UC1: cULus Class 1 Division 2 Products for Hazardous Locations, CU: cUL, N: NK, L: Lloyd, and CE: EC Directives.
- Ask your OMRON representative for the conditions under which the standards were met.
- Low Voltage Directive
Applicable Standard:EN61131-2
VDC must satisfy the appropriate safety requirements. With PLCs, this applies to Power Supply Units and I/O Units that operate in these voltage ranges. These Units have been designed to conform to EN61131-2, which is the applicable standard for PLCs.

● EC Directives

The EC Directives applicable to PLCs include the EMC Directives and the Low Voltage Directive. OMRON complies with these directives as described below.

● EMC Directives

Applicable Standards

EMI: EN61000-6-4, EN61131-2

EMS: EN61000-6-2, EN61131-2

PLCs are electrical devices that are incorporated in machines and manufacturing installations. OMRON PLCs conform to the related EMC standards so that the devices and machines into which they are built can more easily conform to EMC standards. The actual PLCs have been checked for conformity to EMC standards. Whether these

standards are satisfied for the actual system, however, must be checked by the customer.



EMC-related performance will vary depending on the configuration, wiring, and other conditions of the equipment or control panel in which the PLC is installed. The customer must, therefore, perform final checks to confirm that the overall machine or device conforms to EMC standards.

Ordering Information

Basic Configuration Units

CPU Units

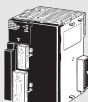
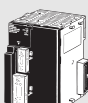
■ CJ1 CPU Units

Product name	Specifications				Current consumption (A)		Model	Standards
	I/O capacity/ Mountable Units (Expansion Racks)	Program capacity	Data memory capacity	LD instruction execution time	5 V	24 V		
CJ1-H-R CPU Units 	2,560 points/ 40 Units (3 Expansion Racks max.)	250K steps	448K words (DM: 32K words, EM: 32K words × 13 banks)	0.016 μs	0.99 (See note 1.)	---	CJ1H-CPU67H-R ^{NEW}	UC1, N, L, CE
		120K steps	256K words (DM: 32K words, EM: 32K words × 7 banks)		0.99 (See note 1.)	---	CJ1H-CPU66H-R ^{NEW}	
		60K steps	128K words (DM: 32K words, EM: 32K words × 3 banks)		0.99 (See note 1.)	---	CJ1H-CPU65H-R ^{NEW}	
		30K steps	64K words (DM: 32K words, EM: 32K words × 1 bank)		0.99 (See note 1.)	---	CJ1H-CPU64H-R ^{NEW}	
CJ1H-H CPU Units 	2,560 points/ 40 Units (3 Expansion Racks max.)	250K steps	448K words (DM: 32K words, EM: 32K words × 13 banks)	0.02 μs	0.99 (See note 1.)	---	CJ1H-CPU67H	UC1, N, L, CE
		120K steps	256K words (DM: 32K words, EM: 32K words × 7 banks)		0.99 (See note 1.)	---	CJ1H-CPU66H	
		60K steps	128K words (DM: 32K words, EM: 32K words × 3 banks)		0.99 (See note 1.)	---	CJ1H-CPU65H	
CJ1G-H CPU Units 	1,280 points/ 40 Units (3 Expansion Racks max.)	60K steps	128K words (DM: 32K words, EM: 32K words × 3 banks)	0.04 μs	0.91 (See note 1.)	---	CJ1G-CPU45H	UC1, N, L, CE
		30K steps	64K words (DM: 32K words, EM: 32K words × 1 bank)		0.91 (See note 1.)	---	CJ1G-CPU44H	
	960 points/ 30 Units (2 Expansion Racks max.)	20K steps			0.91 (See note 1.)	---	CJ1G-CPU43H	
		10K steps	0.91 (See note 1.)		---	CJ1G-CPU42H		
CJ1M CPU Units Without built-in I/O 	640 points/ 20 Units (1 Expansion Racks max.)	20K steps	32 K words (DM: 32K words, EM: None)	0.1 μs	0.58 (See note 1.)	---	CJ1M-CPU13	UC1, N, L, CE
	320 points/ 10 Units (No Expansion Rack)	10K steps			0.58 (See note 1.)	---	CJ1M-CPU12	
	160 points/ 10 Units (No Expansion Rack)	5K steps			0.58(See note 1.)	---	CJ1M-CPU11 (See note 2.)	

Note 1. Current consumptions include current for a Programming Console. Add 0.15 A per Adapter when using NT-AL001 RS-232C/RS-232A Adapters. Add 0.04 A per Adapter when using CJ1W-CIF11 RS-422A Adapters.

2. Some specifications of the low-end CJ1M (CJ1M-CPU11/21) differ from those of the CJ1M-CPU12/13/22/23 as shown in the following table.

■ CJ1 CPU Units (with Built-in I/O)

Product name		Specifications					Current consumption (A)		Model	Standards
		I/O capacity/ Mountable Units (Expansion Racks)	Program capacity	Data memory capacity	LD instruction execution time	Built-in I/O	5 V	24 V		
CJ1M CPU Units	 Built-in I/O (See note 2.)	640 points/ 20 Units (1 Expansion Racks max.)	20K steps	32K words (DM: 32K words, EM: None)	0.1 μs	10 inputs and 6 outputs, 2 counter inputs, 2 pulse outputs	0.64 (See note 1.)	---	CJ1M-CPU23 (See note 3.)	UC1, N, L, CE
		320points/ 10 Units (No Expansion Rack)	10K steps				0.64 (See note 1.)	---	CJ1M-CPU22 (See note 3.)	
		160 points/ 10 Units (No Expansion Rack)	5K steps				0.64 (See note 1.)	---	CJ1M-CPU21 (See notes 2 and 3.)	

- Note 1.** Current consumptions include current for a Programming Console. Add 0.15 A per Adapter when using NT-AL001 RS-232C/RS-232A Adapters. Add 0.04 A per Adapter when using CJ1W-CIF11 RS-422A Adapters.
- 2.** Some specifications of the low-end CJ1M (CJ1M-CPU11/21) differ from those of the CJ1M-CPU12/13/22/23 as shown in the following table.
- 3.** The connector for built-in I/O in the CJ1M-CPU21/22/23 is not included. Purchase one of the connectors or connector cables in the following table separately.

■ CJ1 Loop-control CPU Units

Product name		Specifications		Current consumption (A)		Model	Standards
		CPU Unit	Loop Controller	5 V	24 V		
CJ1G Loop-control CPU Units		Same as for CJ1G-CPU45H.	Number of function blocks: 300 blocks max.	1.06 (See note.)	---	CJ1G-CPU45P	UC1, CE
		Same as for CJ1G-CPU44H.		1.06 (See note.)	---	CJ1G-CPU44P	
		Same as for CJ1G-CPU43H.		1.06 (See note.)	---	CJ1G-CPU43P	
		Same as for CJ1G-CPU42H.	Number of function blocks: 50 blocks max.	1.06 (See note.)	---	CJ1G-CPU42P	

Note: Current consumptions include current for a Programming Console. Add 0.15 A per Adapter when using NT-AL001 RS-232C/RS-232A Adapters. Add 0.04 A per Adapter when using CJ1W-CIF11 RS-422A Adapters.

	CJ1M-CPU11	CJ1M-CPU12 CJ1M-CPU13	CJ1M-CPU21	CJ1M-CPU22 CJ1M-CPU23
Overhead time	0.7 ms	0.5 ms	0.7 ms	0.5ms
Pulse start time	---	---	63 μs (without acceleration/ deceleration, continuous)	46 μs (without acceleration/ deceleration, continuous)
			100 μs (trapezoidal control)	70 μs (trapezoidal control)
Number of subroutines and jumps	256	1024	256	1024
Number of scheduled interrupt tasks	1	2	1	2
Number of PMW outputs	---	---	1	2

● Connector Cables for Built-in I/O in CJ1M-CPU□2 CPU Units

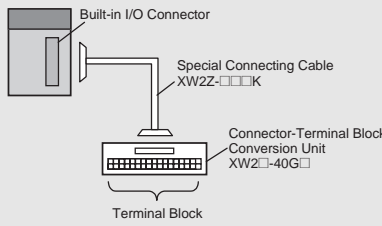
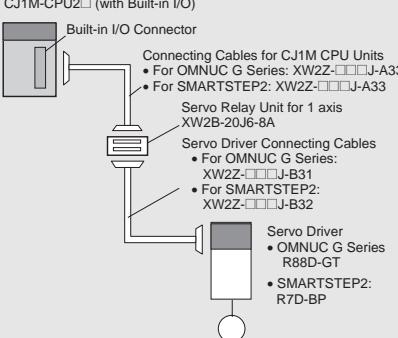

The connector for built-in I/O in the CJ1M-CPU21/22/23 is not included.

Purchase one of the connectors or connector cables in the following table separately.

Product name		Specifications		Model	Standards		
Applicable Connector 		MIL Flat Cable Connectors (Pressure-fitted Connectors)		XG4M-4030-T	---		
Normal Connection Method for Built-in I/O (When Connector-Terminal Block Conversion Unit is Used) CJ1M-CPU2□ (with Built-in I/O) 	Connector-Terminal Block Conversion Units	Slim type (M3 screw terminals, 40-pin)		XW2D-40G6	---		
		Through type (M3 screw terminals, 40-pin)		XW2B-40G4			
		Through type (M3.5 screw terminals, 40-pin)		XW2B-40G5			
		Special Connecting Cables	Cable length: 1 m	XW2Z-100K			
			Cable length: 1.5 m	XW2Z-150K			
Cable length: 2 m	XW2Z-200K						
Cable length: 3 m	XW2Z-300K						
		Cable length: 5 m	XW2Z-500K				
Connection to Servo Driver with Built-in I/O CJ1M-CPU2□ (with Built-in I/O)  <p>When two axes are used, two Connecting Cables are required at the Servo Driver for each Servo Relay Unit.</p>	Servo Relay Units	Servo Relay Unit for 1 axis		XW2B-20J6-8A	---		
		Servo Relay Unit for 2 axes		XW2B-40J6-9A			
		OMNUC G Series	Cable for CJ1M CPU Unit			Cable length: 0.5 m	XW2Z-050J-A33
						Cable length: 1 m	XW2Z-100J-A33
			Servo Driver Connecting Cables			Cable length: 1 m	XW2Z-100J-B31
						Cable length: 2 m	XW2Z-200J-B31
		SMARTSTEP2	Cable for CJ1M CPU Unit			Cable length: 0.5 m	XW2Z-050J-A33
						Cable length: 1 m	XW2Z-100J-A33
			Servo Driver Connecting Cables			Cable length: 1 m	XW2Z-100J-B32
						Cable length: 2 m	XW2Z-200J-B32
		SMARTSTEP Junior	Cable for CJ1M CPU Unit			Cable length: 1 m	XW2Z-100J-A26
			Servo Driver Connecting Cables			Cable length: 1 m	XW2Z-100J-B17
		SMARTSTEP A Series	Cable for CJ1M CPU Unit			Cable length: 1 m	XW2Z-100J-A26
						Cable length: 1 m	XW2Z-100J-B5
						Cable length: 2 m	XW2Z-200J-B5
			Servo Driver Connecting Cables			Cable length: 1 m	XW2Z-100J-B4
		OMNUC W Series	Cable for CJ1M CPU Unit			Cable length: 0.5 m	XW2Z-050J-A27
						Cable length: 1 m	XW2Z-100J-A27
Servo Driver Connecting Cables			Cable length: 1 m	XW2Z-100J-B4			
			Cable length: 2 m	XW2Z-200J-B4			

Power Supply Units

One Power Supply Unit is required for each Rack.

Product name	Power supply voltage	Output capacity			24-VDC service power supply	Options		Model	Standards
		5-VDC output capacity	24-VDC output capacity	Total power consumption		RUN output	Maintenance forecast monitor		
 AC Power Supply Unit	100 to 240 VAC	5 A	0.8 A	25 W	No	No	Yes	CJ1W-PA205C	UC1, N, L, CE
						Yes	No	CJ1W-PA205R	
		2.8 A	0.4 A	14 W		No	No	No	
 DC Power Supply Unit	24 VDC	5A	0.8 A	25 W	No	No	No	CJ1W-PD025	UC1, CE
		2 A	0.4 A	19.6 W		No	No	CJ1W-PD022	

Expansion Racks

Select the I/O Control Unit, I/O Interface Unit, Expansion Connecting Cable, and CJ-series Power Supply Unit.

CJ-series I/O Control Unit (Mounted on CPU Rack when Connecting Expansion Racks)

Product name	Specifications	Current consumption (A)		Model	Standards
		5 V	24 V		
 CJ-series I/O Control Unit	Mount one I/O Control Unit on the CJ-series CPU Rack when connecting one or more CJ-series Expansion Racks. Connecting Cable: CS1W-CN□□3 Expansion Connecting Cable Connected Unit: CJ1W-II101 I/O Interface Unit Mount to the right of the CPU Unit.	0.02	---	CJ1W-IC101	UC1, N, L, CE

Note: Mounting the I/O Control Unit in any other location may cause faulty operation.

CJ-series I/O Interface Unit (Mounted on Expansion Rack)

Product Name	Specifications	Current consumption (A)		Model	Standards
		5 V	24 V		
 CJ-series I/O Interface Unit	One I/O Interface Unit is required on each Expansion Rack. Connecting Cable: CS1W-CN□□3 Expansion Connecting Cable Mount to the right of the CPU Unit.	0.13	---	CJ1W-II101	UC1, N, L, CE

Note: Mounting the I/O Interface Unit in any other location may cause faulty operation.

I/O Connecting Cables

Product name	Specifications	Model	Standards	
I/O Connecting Cable 	<ul style="list-style-type: none"> Connects an I/O Control Unit on CJ-series CPU Rack to an I/O Interface Unit on a CJ-series Expansion Rack. or Connects an I/O Interface Unit on CJ-series Expansion Rack to an I/O Interface Unit on another CJ-series Expansion Rack. 	Cable length: 0.3 m	CS1W-CN313	N, L, CE
		Cable length: 0.7 m	CS1W-CN713	
		Cable length: 2 m	CS1W-CN223	
		Cable length: 3 m	CS1W-CN323	
		Cable length: 5 m	CS1W-CN523	
		Cable length: 10 m	CS1W-CN133	
		Cable length: 12 m	CS1W-CN133-B2	





Programming Devices

Support Software

Product name	Specifications	Number of licenses		Media	Model	Standards
FA Integrated Tool Package CX-One Ver. 2.□	The CX-One is a comprehensive software package that integrates Support Software for OMRON PLCs and components. CX-One runs on the following OS. Windows 98 SE, Me, NT4.0 (Service Pack 6a), 2000 (Service Pack 3 or higher), XP, or Vista CX-One Version 2.□ includes CX-Programmer Ver.7.□ and CX-Simulator Ver. 1.□. For details, refer to the CX-One catalog (Cat. No. R134).	1 license		CD	CXONE-AL01C-EV2	---
				DVD	CXONE-AL01D-EV2	
		3 licenses		CD	CXONE-AL03C-EV2	
				DVD	CXONE-AL03D-EV2	
		10 licenses		CD	CXONE-AL10C-EV2	
				DVD	CXONE-AL10D-EV2	
		30 licenses		CD	CXONE-AL30C-EV2	
				DVD	CXONE-AL30D-EV2	
		50 licenses		CD	CXONE-AL50C-EV2	
				DVD	CXONE-AL50D-EV2	
CX-Programmer and CX-Simulator can still be ordered individually in the following model numbers.						
CX-Programmer Ver.7.□	PLC programming software OS: Windows 98SE, Me, NT4.0 (Service Pack 6a), 2000 (Service Pack 3 or higher), XP, or Vista	1 license		CD	WS02-CXPC1-E-V7□	---
		3 licenses		CD	WS02-CXPC1-E03-V7□	
		10 licenses		CD	WS02-CXPC1-E10-V7□	

- Note**
1. Site licenses are available for users who will run CX-One on multiple computers. Ask your OMRON sales representative for details.
 2. The CX-Thermo Temperature Controller Support Software runs only on Windows 2000 (Service Pack 3 or later), XP, or Vista.
 3. When purchasing the DVD format, verify the computer model and DVD drive specifications before purchasing.

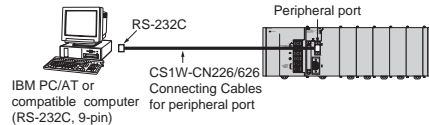
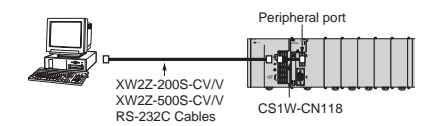
■ Cables for Connecting to Support Software in the CX-One (e.g., the CX-Programmer)

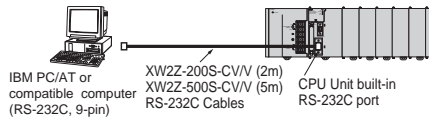
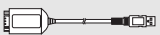
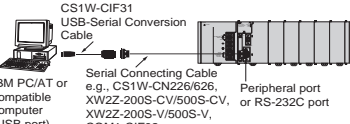

Product Name		Specifications				Model	Standards
		Applicable computers	Connection configuration	Cable length	Remarks		
Programming Device Connecting Cables for Peripheral Port  	Connects IBM PC/AT or compatible computers, D-Sub 9-pin	IBM PC/AT or compatible computer + CS1W-CN226/626 + CPU Unit peripheral port 	2 m	Used for Peripheral Bus or Host Link.	CS1W-CN226	CE	
		IBM PC/AT or compatible computer (RS-232C, 9-pin) CS1W-CN226/626 Connecting Cables for peripheral port	6 m		CS1W-CN626		
		The following connection method can be used when connecting to an IBM PC/AT or compatible computer via RS-232C cable: IBM PC/AT or compatible computer + XW2Z-200S-CV/V or XW2Z-500S-CV/V + CS1W-CN118 + CPU Unit peripheral port 	0.1 m	Used for connecting XW2Z-200S-CV/V or XW2Z-500S-CV/V RS-232C Cable to the peripheral port.	CS1W-CN118	CE	
Programming Device Connecting Cables for RS-232C Port 	Connects IBM PC/AT or compatible computers, D-Sub 9-pin	IBM PC/AT or compatible computer + XW2Z-200S-CV/V or XW2Z-500S-CV/V + RS-232C port of CPU Unit or Serial Communications Board or Unit 	2 m	Used for Peripheral Bus or Host Link. Anti-static connectors	XW2Z-200S-CV	---	
			5 m		XW2Z-500S-CV		
			2 m	Used for Host Link only. Peripheral Bus not supported.	XW2Z-200S-V		
			5 m	XW2Z-500S-V			
USB-Serial Conversion Cable and PC driver (on a CD-ROM disk)  Complies with USB Specification 1.1.	IBM PC/AT or compatible computer (USB port)	IBM PC/AT or compatible computer + CS1W-CIF31 + CS1W-CN226/626 + CPU Unit peripheral port 	0.5 m	Used for Peripheral Bus or Host Link.	CS1W-CIF31	N	
		IBM PC/AT or compatible computer + CS1W-CIF31 + XW2Z-200S-CV/500S-CV + CS1W-CN118 + CPU Unit peripheral port Serial Connecting Cable e.g., CS1W-CN226/626, XW2Z-200S-CV/500S-CV, or RS-232C port					
		IBM PC/AT or compatible computer + CS1W-CIF31 + XW2Z-200S-V/500S + CS1W-CN118 + CPU Unit peripheral port XW2Z-200S-V/500S-V, CQM1-CIF02					
		IBM PC/AT or compatible computer + CS1W-CIF31 + XW2Z-200S-CV/500S-CV + RS-232C port of CPU Unit or Serial Communications Unit					
		IBM PC/AT or compatible computer + CS1W-CIF31 + XW2Z-200S-V/500S-V + RS-232C port of CPU Unit or Serial Communications Unit					

<Note>

There are two serial communications modes for connecting Support Software in the CX-One (e.g., the CX-Programmer) to the CJ Series.

Serial communications mode	Features
Peripheral Bus	High-speed communications are enabled in the Peripheral Bus Mode, so normally connect with this serial communications mode when using Support Software in the CX-One, such as the CX-Programmer <ul style="list-style-type: none"> Supported for 1:1 connection only. The baud rate at the Support Software is automatically recognized when the connection is made.
Host Link (SYSWAY)	Host Link (SYSWAY) is generally the protocol for communications with a host computer. Either a 1:1 or 1:N connection can be used. <ul style="list-style-type: none"> Slower than the peripheral bus. Connections is possible via a modem or optical adapter, long-distance connection is possible using RS-422A/485, and 1:N connections are possible.

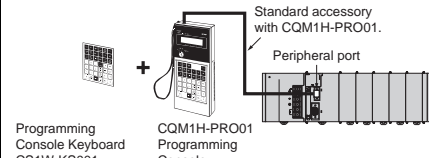
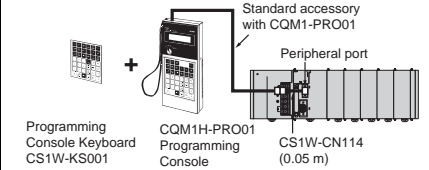
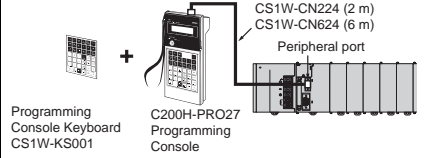
■ Programming Consoles

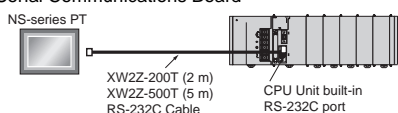

Product name	Specifications	Cable model (Purchased separately.)	Connection configuration	Model	Standards
Programming Consoles 	Connects to peripheral port on CPU Unit only. (No connection is required at the RS-232C port.) An English Keyboard Sheet (CS1W-KS001-E) is required.	Not required. (Cable is included.)		CQM1H-PRO01-E	U, C, N, CE
		CS1W-CN114: 0.05 m		CQM1-PRO01-E	
		CS1W-CN224: 2 m CS1W-CN624: 6 m		C200H-PRO27-E	
Programming Console Key Sheet	For CQM1H-PRO01-E, CQM1-PRO01-E, and C200H-PRO27-E.			CS1W-KS001-E	CE
Programming Console Connecting Cables 	Connects the CQM1-PRO01-E Programming Console. (Length: 0.05 m)			CS1W-CN114	
	Connects the C200H-PRO27-E Programming Console. (Length: 2 m)			CS1W-CN224	
	Connects the C200H-PRO27-E Programming Console. (Length: 6 m)			CS1W-CN624	

■ NS-series PT Connecting Cables



Product name	Specifications		Model	Standards
	Connection configuration	Cable length		
NS-series PT Connecting Cables 	Cable for connecting between an NS-series PT and the RS-232C port on the CPU Unit or Serial Communications Board 	2 m	XW2Z-200T	---
		5 m	XW2Z-500T	
	Cable for connecting between an NS-series PT and the peripheral port on the CPU Unit	2 m	XW2Z-200T-2	
		5 m	XW2Z-500T-2	

Optional Products and Maintenance Products

Product name	Specifications	Model	Standards
Memory Cards 	Flash memory, 128 MB	HMC-EF183	N, L, CE
	Memory Card Adapter (for computer PCMCIA slot)	HMC-AP001	CE

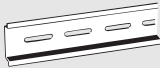

Product name	Specifications	Model	Standards	
Battery Set 	Battery for CJ1G/H-CPU□□H-R/H/P CPU Unit maintenance	Note 1. The battery is included as a standard accessory with the CPU Unit. 2. The battery service life is 5 years at 25°C. (The service life depends on the ambient operating temperature and the power conditions.) 3. Use batteries within two years of manufacture.	CPM2A-BAT01	L, CE
	Battery for CJ1M-CPU□□CPU Unit maintenance		CJ1W-BAT01	CE
End Cover 	Mounted to the right-hand side of CJ-series CPU Racks or Expansion Racks.	One End Cover is provided as a standard accessory with each CPU Unit and I/O Interface Unit.	CJ1W-TER01	UC1, N, L, CE
RS-422A Adapter 	Converts RS-232C to RS-422A/RS-485. (Application example: With a CJ1M CPU Unit, the Adapter is used for Serial PLC Link at the built-in RS-232C port of the CPU Unit.)		CJ1W-CIF11	UC1, N, L, CE

DIN Track Accessories

Product name	Specifications	Model	Standards
DIN Track 	Length: 0.5 m; Height: 7.3 mm	PFP-50N	---
	Length: 1 m; Height: 7.3 mm	PFP-100N	
	Length: 1 m; Height: 16 mm	PFP-100N2	
End Plate 	There are 2 stoppers provided with CPU Units and I/O Interface Units as standard accessories to secure the Units on the DIN Track.	PFP-M	





Basic I/O Units

Input Units

Unit classification	Product name	Specifications						Current consumption (A)		Model	Standards
		I/O points	Input voltage and current	Commons	Additional functions	External connection	No. of words allocated	5 V	24 V		
CJ1 Basic I/O Units	DC Input Units 	8 inputs	12 to 24 VDC, 10 mA	Independent contacts	---	Removable terminal block	1 word	0.09	---	CJ1W-ID201	UC1, N, L, CE
		16 inputs	24 VDC, 7 mA	16 points, 1 common		Removable terminal block	1 word	0.08	---	CJ1W-ID211	
		32 inputs	24 VDC, 4.1 mA	16 points, 1 common		Fujitsu connector	2 words	0.09	---	CJ1W-ID231 (See note.)	
		32 inputs	24 VDC, 4.1 mA	16 points, 1 common		MIL connector	2 words	0.09	---	CJ1W-ID232 (See note.)	
		64 inputs	24 VDC, 4.1 mA	16 points, 1 common		Fujitsu connector	4 words	0.09	---	CJ1W-ID261 (See note.)	
		64 inputs	24 VDC, 4.1 mA	16 points, 1 common		MIL connector	4 words	0.09	---	CJ1W-ID262 (See note.)	
	AC Input Units 	16 inputs	100 to 120 VAC, 7 mA (100 V, 50 Hz)	16 points, 1 common		Removable Terminal Block	1 words	0.09	---	CJ1W-IA111	
		8 inputs	200 to 24 VAC, 10 mA (200 V, 50 Hz)	8 points, 1 common		Removable Terminal Block	1 words	0.08	---	CJ1W-IA201	

Note: Connectors are not provided with these connector models. Either purchase one of the following 40-pin Connectors, or use an OMRON XW2 Connector-Terminal Block Conversion Unit or a G7 I/O Relay Terminal.

■ Output Units

Unit classification	Product name	Specifications					No. of words allocated	Current consumption (A)		Model	Standards
		I/O points	Maximum switching capacity	Commons	Additional functions	External connection		5 V	24 V		
CJ1 Basic I/O Units	Relay Contact Output Units 	8 outputs	250 VAC/24 VDC, 2 A	Independent contacts	---	Removable terminal block	1 words	0.09	0.048 max.	CJ1W-OC201	UC1, N, L, CE
		16 outputs	250 VAC/24 VDC, 2 A	16 points, 1 common		Removable terminal block	1 words	0.11	0.096 max.	CJ1W-OC211	
	Transistor Output Units   	8 outputs	12 to 24 VDC, 2 A, sinking,	4 points, 1 common		Removable terminal block	1 words	0.09	---	CJ1W-OD201	
		8 outputs	24 VDC, 2 A, sourcing	4 points, 1 common	Short-circuit protection, disconnection detection	Removable terminal block	1 words	0.11	---	CJ1W-OD202	
		8 outputs	12 to 24 VDC, 0.5 A, sinking	8 points, 1 common	---	Removable terminal block	1 words	0.10	---	CJ1W-OD203	
		8 outputs	24 VDC, 0.5 A, sourcing	8 points, 1 common	Short-circuit protection	Removable terminal block	1 words	0.10	---	CJ1W-OD204	
		16 outputs	12 to 24 VDC, 0.5 A, sinking	16 points, 1 common	---	Removable terminal block	1 words	0.10	---	CJ1W-OD211	
		16 outputs	24 VDC, 0.5 A,	16 points, 1 common	Short-circuit protection	Removable terminal block	1 words	0.10	---	CJ1W-OD212	
		32 outputs	12 to 24 VDC, 0.5 A, sinking	16 points, 1 common	---	Fujitsu connector	2 words	0.14	---	CJ1W-OD231 (See note.)	
		32 outputs	24 VDC, 0.5 A, sourcing	16 points, 1 common	Short-circuit protection	MIL connector	2 words	0.15	---	CJ1W-OD232 (See note.)	
		32 outputs	12 to 24 VDC, 0.5 A, sinking	16 points, 1 common	---	MIL connector	2 words	0.14	---	CJ1W-OD233 (See note.)	
		64 outputs	12 to 24 VDC, 0.3 A, sinking	16 points, 1 common	---	Fujitsu connector	4 words	0.17	---	CJ1W-OD261 (See note.)	
		64 outputs	12 to 24 VDC, 0.3 A, sourcing	16 points, 1 common	---	MIL connector	4 words	0.17	---	CJ1W-OD262 (See note.)	
		64 outputs	12 to 24 VDC, 0.3 A, sinking	16 points, 1 common	---	MIL connector	4 words	0.17	---	CJ1W-OD263 (See note.)	
Triac Output Unit 	8 outputs	250 VAC, 0.6 A	8 points, 1 common	---	Removable terminal block	1 words	0.22	---	CJ1W-OA201		

Note: Connectors are not provided with these connector models. Either purchase one of the following 40-pin Connectors, or use an OMRON XW2□ Connector-Terminal Block Conversion Unit or a G7□ I/O Relay Terminal.

■ I/O Units

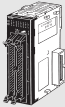
Unit classification	Product name	Specifications						Current consumption (A)		Model	Standards	
		I/O points	Input voltage, Input current	Commons	Additional functions	External connection	No. of words allocated	5 V	24 V			
			Maximum switching capacity									
CJ1 Basic I/O Units	DC Input/Transistor Output Units 	16 inputs	24 VDC, 7 mA	16 points, 1 common	---	Fujitsu connector	2 words	0.13	---	CJ1W-MD231 (See note 2.)	UC1, N, CE	
		16 outputs	250 VAC/24 VDC, 0.5 A, sinking	16 points, 1 common	---	---	---	---	---	---	---	---
		16 inputs	24 VDC, 7 mA	16 points, 1 common	---	---	MIL connector	2 words	0.13	---	CJ1W-MD232 (See note 2.)	UC1, N, L, CE
		16 outputs	24 VDC, 0.5 A, sourcing	16 points, 1 common	Short-circuit protection	---	---	---	---	---	---	---
		16 inputs	24 VDC, 7 mA	16 points, 1 common	---	---	MIL connector	2 words	0.13	---	CJ1W-MD233 (See note 2.)	UC1, N, CE
		16 outputs	12 to 24 VDC, 0.5 A, sinking	16 points, 1 common	---	---	---	---	---	---	---	
		32 inputs	24 VDC, 4.1 mA	16 points, 1 common	---	---	Fujitsu connector	4 words	0.14	---	CJ1W-MD261 (See note 1.)	
		32 outputs	12 to 24 VDC, 0.3 A, sinking	16 points, 1 common	---	---	---	---	---	---	---	
		32 inputs	24 VDC, 4.1 mA	16 points, 1 common	---	---	MIL connector	4 words	0.14	---	CJ1W-MD263 (See note 1.)	
		32 outputs	12 to 24 VDC, 0.3 A, sinking	16 points, 1 common	---	---	---	---	---	---	---	
TTL I/O Units		32 inputs	5 VDC, 35 mA	16 points, 1 common	---	---	---	---	---	CJ1W-MD563 (See note 1.)		
		32 outputs	5 VDC, 35 mA	16 points, 1 common	---	MIL connector	4 words	0.19	---			

Note 1. Connectors are not provided with these connector models. Either purchase one of the following 40-pin Connectors, or use an OMRON XW2□ Connector-Terminal Block Conversion Unit or a G7□ I/O Relay Terminal.

2. Connectors are not provided with these connector models. Either purchase one of the following 20-pin or 24-pin Connectors, or use an OMRON XW2□ Connector-Terminal Block Conversion Unit or a G7□ I/O Relay Terminal.

● Applicable Connectors

Fujitsu Connectors for 32-input, 32-output, 64-input, 64-output, 32-input/32-output, and 16-input/16-output Units

Name	Connection	Remarks	Applicable Units	Model	Standards
40-pin Connectors	Soldered	FCN-361J040-AU Connector FCN-360C040-J2 Connector Cover	Fujitsu Connectors: CJ1W-ID231(32 inputs): 1 per Unit CJ1W-ID261 (64 inputs) 2 per Unit CJ1W-OD231 (32 outputs):1 per Unit CJ1W-OD261 (64 outputs): 2 per Unit CJ1W-MD261 (32 inputs, 32 outputs): 2 per Unit	C500-CE404	---
	Crimped	FCN-363J040 Housing FCN-363J-AU Contactor FCN-360C040-J2 Connector Cover		C500-CE405	
	Pressure welded	FCN-367J040-AU/F		C500-CE403	
24-pin Connectors	Soldered	FCN-361J024-AU Connector FCN-360C024-J2 Connector Cover	Fujitsu Connectors: CJ1W-MD231 (16 inputs, 16 outputs): 2 per Unit	C500-CE241	
	Crimped	FCN-363J024 Housing FCN-363J-AU Contactor FCN-360C024-J2 Connector Cover		C500-CE242	
	Pressure welded	FCN-367J024-AU/F		C500-CE243	

MIL Connectors for 32-input, 32-output, 64-input, 64-output, 32-input/32-output, and 16-input/16-output Units

Name	Connection	Remarks	Applicable Units	Model	Standards
40-pin Connectors	Pressure welded	FRC5-AO40-3TOS	MIL Connectors: CJ1W-ID232 (32 inputs): 1 per Unit CJ1W-OD232/233 (32 outputs): 1 per Unit CJ1W-ID262 (64 inputs): 2 per Unit CJ1W-OD262/263 (64 outputs): 2 per Unit CJ1W-MD263/563 (32 inputs, 32 outputs): 2 per Unit	XG4M-4030-T	---
20-pin Connectors	Pressure welded	FRC5-AO20-3TOS	MIL Connectors: CJ1W-MD232/233 (16 inputs, 16 outputs): 2 per Unit	XG4M-2030-T	

Interrupt Input Units

Unit classification	Product name	Specifications						No. of words allocated	Current consumption (A)		Model	Standards
		I/O points	Input voltage current	Commons	Input pulse width conditions	Max. Units mountable per Unit	External connection		5 V	24 V		
CJ1 Basic I/O Units	Interrupt Input Unit 	16 inputs	24 VDC, 7 mA	16 points, 1 common	ON time: 0.05 ms max. OFF time: 0.5 ms max.	2	Removable terminal block	1 word	0.08	---	CJ1W-INT01	UC1, N, L, CE

Note 1. Can be used only on CPU Racks, and not on Expansion Racks.
 2. The locations where the Units can be mounted depend on the CPU Rack and the CPU Unit model.
 CJ1G, CJ1H: From the slot next to the CPU Unit until the fifth slot.
 CJ1M: From the slot next to the CPU Unit until the third slot.

High-speed Input Units

Unit classification	Product name	Specifications						No. of words allocated	Current consumption (A)		Model	Standards
		I/O points	Input voltage, Input current	Commons	Input pulse width conditions	External connection	5 V		24 V			
CJ1 Basic I/O Units	High-speed Input Unit 	16 inputs	24 VDC, 7 mA	16 points, 1 common	ON time: 0.05 ms max. OFF time: 0.5 ms max.	Removable terminal block	1 word	0.08	---	CJ1W-IDP01	UC1, N, L, CE	

Note: There are no restrictions on the mounting position or number of Units.

B7A Interface Units

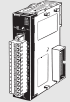
Unit classification	Product name	Specifications		No. of words allocated	Current consumption (A)		Model	Standards
		I/O points	External connection		5 V	24 V		
CJ1 Basic I/O Units	B7A Interface Units 	64 inputs	Removable terminal block	4 words	0.07	---	CJ1W-B7A14	UC1, CE
		64 outputs			0.07	---	CJ1W-B7A04	
		32 inputs/outputs			0.07	---	CJ1W-B7A22	

Special I/O Units and CPU Bus Units

■ Process I/O Units

● Isolated-type Units with Universal Inputs

Unit classification	Product name	Input points	Signal range selection	Signal range	Conversion speed (resolution)	Accuracy (at ambient temperature of 25°C)	External connection	No. of unit numbers allocated	Current consumption (A)		Model	Standards
									5 V	24 V		
CJ1 Special I/O Units	Process Input Units (Isolated-type Units with Universal Inputs) 	4 inputs	Set separately for each input	Universal inputs: Pt100 (3-wire), JPt100 (3-wire), Pt1000 (3-wire), Pt100 (4-wire), K, J, T, E, L, U, N, R, S, B, WRe5-26, PL II, 4 to 20 mA, 0 to 20 mA, 1 to 5 V, 0 to 1.25 V, 0 to 5 V, 0 to 10 V, ±100 mV selectable range -1.25 to 1.25 V, -5 to 5 V, -10 to 10 V, ±10 V selectable range, potentiometer	Resolution (conversion speed): 1/256,000 (conversion cycle: 60 ms/4 inputs) 1/64,000 (conversion cycle: 10 ms/4 inputs) 1/16,000 (conversion cycle: 5 ms/4 inputs)	Standard accuracy: ±0.05% of F.S.	Removable terminal block	1	0.30	---	Available soon CJ1W-PH41U	---
		4 inputs	Set separately for each input	Universal inputs: Pt100, JPt100, Pt1000, K, J, T, L, R, S, B, 4 to 20 mA, 0 to 20 mA, 1 to 5 V, 0 to 5 V, 0 to 10 V	Conversion speed: 250 ms/4 inputs	Accuracy: Platinum resistance thermometer input: (±0.3% of PV or ±0.8°C, whichever is larger) ±1 digit max. Thermocouple input: (±0.3% of PV or ±1.5°C, whichever is larger) ±1 digit max. (See note.) Voltage or current input: ±0.3% of F.S. ±1 digit max.			0.32	---	Available soon CJ1W-AD04U	---

Note: L and -100°C or less for K and T are ±2°C±1 digit max., and 200°C or less for R and S is ±3°C±1 digit max. No accuracy is specified for 400°C or less for B.

● Isolated-type Thermocouple Input Units

Unit classification	Product name	Input points	Signal range selection	Signal range	Conversion speed (resolution)	Accuracy (at ambient temperature of 25°C)	External connection	No. of unit numbers allocated	Current consumption (A)		Model	Standards
									5 V	24 V		
CJ1 Special I/O Units	Process Input Units (Isolated-type Thermocouple Input Units) 	2 inputs	Set separately for each input	Thermocouple: B, E, J, K, L, N, R, S, T, U, WRe5-26, PLII DC voltage: ±100 mV	Conversion speed: 10 ms/ 2 inputs, Resolution: 1/64,000	Standard accuracy: ±0.05% of F.S. (See note 1.)	Removable terminal block	1	0.18	0.06 (See note 2.)	CJ1W-PTS15	UC1, CE
		4 inputs	Thermocouple: R, S, K, J, T, L, B	Conversion speed: 250 ms/ 4 inputs	Accuracy: (±0.3% of PV or ±1°C, whichever is larger) ±1 digit max. (See note 3.)	0.25			---	CJ1W-PTS51		

Note 1. The accuracy depends on the sensors used and the measurement temperatures. For details, refer to the user's manual.

Note 2. This is for an external power supply, and not for internal current consumption.

Note 3. L and -100°C or less for K and T are ±2°C±1 digit max., and 200°C or less for R and S is ±3°C±1 digit max. No accuracy is specified for 400°C or less for B.

● Isolated-type Resistance Thermometer Input Units

Unit classification	Product name	Input points	Signal range selection	Signal range	Conversion speed (resolution)	Accuracy (at ambient temperature of 25°C)	External connection	No. of unit numbers allocated	Current consumption (A)		Model	Standards
									5 V	24 V		
CJ1 Special I/O Units	Process Analog Input Units (Isolated-type Resistance Thermometer Input Units) 	2 inputs	Set separately for each input	Resistance thermometer: Pt100, JPt100, Pt50, Ni508.4	Conversion speed: 10 ms/ 2 inputs, Resolution: 1/64,000	Accuracy: ±0.05% of F.S. or ±0.1°C, whichever is larger.	Removable terminal block	1	0.18	0.07 (See note.)	CJ1W-PTS16	UC1, CE
		4 inputs	Common inputs	Resistance thermometer: Pt100, JPt100	Conversion speed: 250 ms/ 4 inputs	Accuracy: ±0.3°C of PV or ±0.8°C, whichever is larger, ±1 digit max.			0.25	---	CJ1W-PTS52	

Note: This is for an external power supply, and not for internal current consumption.

● Isolated-type DC Input Units

Unit classification	Product name	Input points	Signal range selection	Conversion speed (resolution)	Accuracy (at ambient temperature of 25°C)	External connection	No. of unit numbers allocated	Current consumption (A)		Model	Standards
								5 V	24 V		
CJ1 Special I/O Units	Isolated-type DC Input Units 	2 inputs	DC voltage: 0 to 1.25 V, -1.25 to 1.25 V, 0 to 5 V, 1 to 5 V, -5 to 5 V, 0 to 10 V, -10 to 10 V, ±10 V selectable range DC current: 0 to 20 mA, 4 to 20 mA	Conversion speed: 10 ms/ 2 inputs Resolution: 1/64,000	Standard accuracy: ±0.05% of F.S.	Removable terminal block	1	0.18	0.09 (See note.)	CJ1W-PDC15	UC1, CE

Note: This is for an external power supply, and not for internal current consumption.

■ Analog I/O Units

● Analog Input Units

Unit classification	Product name	Input points	Signal range selection	Signal range	Resolution	Conversion speed	Accuracy (at ambient temperature of 25°C)	External connection	No. of unit numbers allocated	Current consumption (A)		Model	Standards
										5 V	24 V		
CJ1 Special I/O Units	Analog Input Units 	8 inputs	Set separately for each input	1 to 5 V, 0 to 5 V, -10 to 10 V, 4 to 20 mA	1/8000, (Settable to 1/4000) (See note 1.)	250 μs/point max. (Settable to 1 ms/point) (See note 1.)	Voltage: ±0.2% of F.S. Current: ±0.4% of F.S. (See note 2.)	Removable terminal block	1	0.42	---	CJ1W-AD081-V1	UC1, N, L, CE
		4 inputs								0.42	---	CJ1W-AD041-V1	

Note 1. The resolution and conversion speed cannot be set independently. If the resolution is set to 1/4,000, then the conversion speed will be 1 ms/point.
2. At 23 ±2°C

● Analog Output Units

Unit classification	Product name	Output points	Signal range selection	Signal range	Resolution	Conversion speed	Accuracy (at ambient temperature of 25°C)	External connection	External power supply	No. of unit numbers allocated	Current consumption (A)		Model	Standards
											5 V	24 V		
CJ1 Special I/O Units	 Analog Output Units	8 outputs	Set separately for each input	1 to 5 V, 0 to 5 V, -10 to 10 V	1/4,000 (Settable to 1/8,000)	1 ms/point max. (Settable to 250 µs/point)	±0.3% of F.S.	Removable terminal block	24 VDC +10% -15% , 140 mA max.	1	0.14	0.14 (See note.)	CJ1W-DA08V	UC1, N, L, CE
		8 outputs		4 to 20 mA					24 VDC +10% -15% , 170 mA max.		0.14	0.17 (See note.)	CJ1W-DA08C	UC1, N, CE
		4 outputs		1 to 5 V, 0 to 5 V, 0 to 10 V, -10 to 10 V, 4 to 20 mA	1/4000	1 ms/point max.	Voltage output: ±0.3% of F.S. Current output: ±0.5% of F.S.		24 VDC +10% -15% , 200 mA max.		0.12	0.2 (See note.)	CJ1W-DA041	UC1, N, L, CE
		2 outputs							24 VDC +10% -15% , 140 mA max.		0.12	0.14 (See note.)	CJ1W-DA021	

Note: This is for an external power supply, and not for internal current consumption

● Analog I/O Units

Unit classification	Product name	No. of points	Signal range selection	Signal range	Resolution (See note.)	Conversion speed (See note.)	Accuracy (at ambient temperature of 25°C)	External connection	No. of unit numbers allocated	Current consumption (A)		Model	Standards
										5 V	24 V		
CJ1 Special I/O Units	 Analog I/O Units	4 inputs	Set separately for each input	1 to 5 V, 0 to 5 V, 0 to 10 V, -10 to 10 V, 4 to 20 mA	1/4,000 (Settable to 1/8,000)	1 ms/point (Settable to 500 µs/point max.)	Voltage input: ±0.2% of F.S.	Removable terminal block	1	0.58	---	CJ1W-MAD42	UC1, N, L, CE
	2 outputs	Current input: ±0.2% of F.S.					Voltage output: ±0.3% of F.S.						
		Current output: ±0.3% of F.S.											

Note: The resolution and conversion speed cannot be set independently. If the resolution is set to 1/4,000, then the conversion speed will be 1 ms/point.

■ Temperature Control Units

Unit classification	Product name	Specifications			No. of unit numbers allocated	Current consumption (A)		Model	Standards
		No. of loops	Temperature sensor inputs	Control outputs		5 V	24 V		
CJ1 Special I/O Units	 Temperature Control Units	4 loops	Thermocouple input (R, S, K, J, T, B, L)	Open collector NPN outputs (pulses)	2	0.25	---	CJ1W-TC001	UC1, N, L, CE
		4 loops		Open collector PNP outputs (pulses)		0.25	---	CJ1W-TC002	
		2 loops, heater burnout detection function		Open collector NPN outputs (pulses)		0.25	---	CJ1W-TC003	
		2 loops, heater burnout detection function		Open collector PNP outputs (pulses)		0.25	---	CJ1W-TC004	
		4 loops	Platinum resistance thermometer input (JPT100, Pt100)	Open collector NPN outputs (pulses)		0.25	---	CJ1W-TC101	
		4 loops		Open collector PNP outputs (pulses)		0.25	---	CJ1W-TC102	
		2 loops, heater burnout detection function		Open collector NPN outputs (pulses)		0.25	---	CJ1W-TC103	
		2 loops, heater burnout detection function		Open collector PNP outputs (pulses)		0.25	---	CJ1W-TC104	

■ High-speed Counter Unit

Unit classification	Product name	Specifications			No. of unit numbers allocated	Current consumption (A)		Model	Standards
		Countable channels	Encoder A and B inputs, pulse input Z signals	Max. counting rate		5 V	24 V		
CJ1 Special I/O Units	 High-speed Counter Unit	2	Open collector Input voltage: 5 VDC, 12 V, or 24 V (5 V and 12 V are each for one axis only.)	50 kcps	4	0.28	---	CJ1W-CT021	UC1, N, L, CE
			RS-422 line driver	500 kcps					

■ Position Control Units

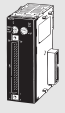
Unit classification	Product name	Specifications		No. of unit numbers allocated	Current consumption (A)		Model	Standards	
		No. of axes	Control output interface		5 V	24 V			
CJ1 Special I/O Units	Position Control Units 	1 axis	Pulse train, open collector output	1	0.25	---	CJ1W-NC113	UC1, CE	
		2 axes	Pulse train, open collector output		0.25	---	CJ1W-NC213		
		4 axes	Pulse train, open collector output (See note 1.)	2	0.36	---	CJ1W-NC413		
		1 axis	Pulse train, line driver output		1	0.25	---		CJ1W-NC133
		2 axes	Pulse train, line driver output	0.25		---	CJ1W-NC233		
		4 axes	Pulse train, line driver output (See note 1.)	2	0.36	---	CJ1W-NC433		
	Space Unit	Use a CJ1W-SP001 Space Unit if the operating temperature is 0 to 55°C.						CJ1W-SP001	UC1, CE
	CX-One FA Integrated Tool Package Ver. 2.0	The CX-One is a package that integrates the Support Software for OMRON PLCs and components. CX-One runs on the following OS. Windows 98SE, Me, NT4.0 (Service Pack 6a), 2000 (Service Pack 3a or higher), XP, or Vista CX-One Ver. 2.0 includes CX-Position Ver. 2.0. For details, refer to the CX-One catalog (Cat. No. R134).			1 license Media: CD (See note 2.)		CXONE-AL01C-EV2	---	
				1 license Media: DVD (See notes 2 and 3.)		CXONE-AL01D-EV2			
	Servo Relay Units	For 1-Axis Position Control Unit (without communications support) (CJ1W-CN113/133)					XW2B-20J6-1B	---	
For 2- or 4-Axis Position Control Unit (without communications support) (CJ1W-NC213/233/413/433)					XW2B-40J6-2B				
For 2- or 4-Axis Position Control Unit (with communications support) (CJ1W-NC213/233/413/433)					XW2B-40J6-4A				
Position Control Unit Cables	For CJ1W-NC113: Pulse train, open collector output, 1 axis		Connecting Servo Driver: OMNUC G/W Series, SMARTSTEP2	Cable length: 0.4 m	XW2Z-050J-A14	---			
	For CJ1W-NC213/413: Pulse train, open collector output, 2 axes/4 axes			Cable length: 1 m	XW2Z-100J-A14				
	For CJ1W-NC113: Pulse train, open collector output, 1 axis		Connecting Servo Driver: SMARTSTEP Junior/A Series	Cable length: 0.5 m	XW2Z-050J-A15				
	For CJ1W-NC213/413: Pulse train, open collector output, 2 axes/4 axes			Cable length: 1 m	XW2Z-100J-A15				
	For CJ1W-NC113: Pulse train, open collector output, 1 axis		Connecting Servo Driver: OMNUC G/W Series, SMARTSTEP2	Cable length: 0.5 m	XW2Z-050J-A16				
	For CJ1W-NC213/413: Pulse train, open collector output, 2 axes/4 axes			Cable length: 1 m	XW2Z-100J-A16				
	For CJ1W-NC133: Pulse train, line-driver output, 1 axis		Connecting Servo Driver: SMARTSTEP Junior/A Series	Cable length: 0.5 m	XW2Z-050J-A17				
	For CJ1W-NC233/433: Pulse train, line driver output, 2 axes/4 axes			Cable length: 1 m	XW2Z-100J-A17				
	For CJ1W-NC133: Pulse train, line-driver output, 1 axis		Connecting Servo Driver: OMNUC G/W Series, SMARTSTEP2	Cable length: 0.5 m	XW2Z-050J-A18				
	For CJ1W-NC233/433: Pulse train, line driver output, 2 axes/4 axes			Cable length: 1 m	XW2Z-100J-A18				
For CJ1W-NC133: Pulse train, line-driver output, 1 axis		Connecting Servo Driver: SMARTSTEP Junior/A Series	Cable length: 0.5 m	XW2Z-050J-A19					
For CJ1W-NC233/433: Pulse train, line driver output, 2 axes/4 axes			Cable length: 1 m	XW2Z-100J-A19					
For CJ1W-NC133: Pulse train, line-driver output, 1 axis		Connecting Servo Driver: SMARTSTEP Junior/A Series	Cable length: 0.5 m	XW2Z-050J-A20					
For CJ1W-NC233/433: Pulse train, line driver output, 2 axes/4 axes			Cable length: 1 m	XW2Z-100J-A20					
For CJ1W-NC133: Pulse train, line-driver output, 1 axis		Connecting Servo Driver: SMARTSTEP Junior/A Series	Cable length: 0.5 m	XW2Z-050J-A21					
For CJ1W-NC233/433: Pulse train, line driver output, 2 axes/4 axes			Cable length: 1 m	XW2Z-100J-A21					

Note 1. The ambient operating temperature for 4-Axis Position Control Units is 0 to 50°C; the allowable voltage fluctuation on the external 24-VDC power supply is 22.8 to 25.2 VDC (24 V ±5%).

2. Site licenses are available for the CX-One (3, 10, 30, or 50 licenses). For details, refer to *Support Software* on page 42.

3. When purchasing the DVD format, verify the computer model and DVD drive specifications before purchasing.

■ MECHATROLINK-II-compatible Position Control Units

Unit classification	Product name	Specifications	No. of unit numbers allocated	Current consumption (A)		Model	Standards
				5 V	24 V		
CJ1 CPU Bus Units	MECHATROLINK-II-compatible Motion Control Units 	Control commands executed by MECHATROLINK-II synchronous communications. 16 axes max. Direct operation by ladder programming. Control mode: Position control, speed control, or torque control	1	0.36	---	CJ1W-NCF71	UC1, CE
	MECHATROLINK-II Interface Unit	R88D-WT□ OMNUC W-series AC Servo Driver (Yaskawa Electric Corporation) Use the model numbers provided in this catalog when ordering from OMRON.				FNY-NS115	---
	MECHATROLINK-II Cables	Connects MECHATROLINK-II-compatible devices (Yaskawa Electric Corporation) Use the model numbers provided in this catalog when ordering from OMRON.	Cable length: 0.5 m		FNY-W6003-A5		---
			Cable length: 1 m		FNY-W6003-01		
			Cable length: 3 m		FNY-W6003-03		
			Cable length: 5 m		FNY-W6003-05		
Cable length: 10 m			FNY-W6003-10				
Cable length: 20 m			FNY-W6003-20				
Cable length: 30 m		FNY-W6003-30					
MECHATROLINK-II Terminating Resistors	Terminating Resistor for MECHATROLINK-II (Yaskawa Electric Corporation) Use the model numbers provided in this catalog when ordering from OMRON.				FNY-W6022	---	
CX-One FA Integrated Tool Package Ver. 2.□	The CX-One is a package that integrates the Support Software for OMRON PLCs and components. CX-One runs on the following OS. Windows 98SE, Me, NT4.0 (Service Pack 6a), 2000 (Service Pack 3a or higher), XP, or Vista CX-One Ver. 2.□ includes CX-Motion-NCF Ver. 1.□. For details, refer to the CX-One catalog (Cat. No. R134).		1 license Media: CD (See note 1.)		CXONE-AL01C-EV2	---	
			1 license Media: DVD (See notes 1 and 2.)		CXONE-AL01D-EV2		

Note 1. Site licenses are available for the CX-One (3, 10, 30, or 50 licenses). For details, refer to *Support Software* on page 42.
Note 2. When purchasing the DVD format, verify the computer model and DVD drive specifications before purchasing.

■ MECHATROLINK-II-compatible Motion Control Units

Unit classification	Product name	Specifications	No. of unit numbers allocated	Current consumption (A)		Model	Standards
				5 V	24 V		
CJ1 CPU Bus Units	MECHATROLINK-II-compatible Motion Control Units 	Position, speed, and torque commands by MECHATROLINK-II 32 axes max. (Physical axes: 30, Virtual axes: 2) Motion control language	1	0.6	0.3	CJ1W-MCH71	UC1, CE
	MECHATROLINK Unit	Refer to the section on <i>MECHATROLINK-II-compatible Position Control Units</i> above on page 55.					
	MECHATROLINK-II Cables	Refer to the section on <i>MECHATROLINK-II-compatible Position Control Units</i> above on page 55.					
	MECHATROLINK-II Terminating Resistors	Refer to the section on <i>MECHATROLINK-II-compatible Position Control Units</i> above on page 55.					
	MECHATROLINK-II Repeater	For more than 15 slaves/30 m				FNY-REP2000	
	MECHATROLINK-II 24-VDC I/O Module	Inputs: 64 Outputs: 64				FNY-IO2310	
	MECHATROLINK-II Counter Module	Reversible counter, 2 words				FNY-PL2900	
	MECHATROLINK-II Pulse Output Module	Pulse train positioning, 2 words				FNY-PL2910	---
	CX-One FA Integrated Tool Package Ver. 2.□	The CX-One is a package that integrates the Support Software for OMRON PLCs and components. CX-One runs on the following OS. Windows 98SE, Me, NT4.0 (Service Pack 6a), 2000 (Service Pack 3a or higher), XP, or Vista CX-One Ver. 2.□ includes CX-Motion-MCH Ver. 2.□. For details, refer to the CX-One catalog (Cat. No. R134).	1 license Media: CD (See note 1.)				CXONE-AL01C-EV2
		1 license Media: DVD (See notes 1 and 2.)				CXONE-AL01D-EV2	

Note 1. Site licenses are available for the CX-One (3, 10, 30, or 50 licenses). For details, refer to *Support Software* on page 42.

2. When purchasing the DVD format, verify the computer model and DVD drive specifications before purchasing.

3. The CJ1W-MCH71 requires the space of three Units (but just one unit number). A maximum of 10 Units can be mounted on a single CJ-series Rack, up to three CJ1W-MCH71 Motion Control Units plus one other Unit can be mounted per Rack.

■ Serial Communications Units

Unit classification	Product name	Specifications		No. of unit numbers allocated	Current consumption (A)		Model	Standards
		Communications Interface	Communications functions		5 V	24 V		
CJ1 CPU Bus Units	Serial Communications Units 	1 RS-232C port and 1 RS-422A/485 port	The following functions can be selected for each port: Protocol macro Host Link NT Links (1:N mode) Serial Gateway (See note 1.) No-protocol (See note 2.) Modbus-RTU Slave (See note 3.)	1	0.38 (See note 4.)	---	CJ1W-SCU41-V1	UC1, N, L, CE
		2 RS-232C ports			0.28 (See note 4.)	---	CJ1W-SCU21-V1	
		2 RS-422A/485 ports			0.38	---	CJ1W-SCU31-V1	
	CX-One FA Integrated Tool Package Ver. 2. □	The CX-One is a package that integrates the Support Software for OMRON PLCs and components. CX-One runs on the following OS. Windows 98SE, Me, NT4.0 (Service Pack 6a), 2000 (Service Pack 3a or higher), XP, or Vista CX-One Ver. 2. □ includes CX-Protocol Ver. 1. □. For details, refer to the CX-One catalog (Cat. No. R134). CX-Protocol can still be ordered individually in the following model number.		1 license Media: CD (See note 5.)			CXONE-AL01C-EV2	---
		1 license Media: DVD (See notes 5 and 6.)			CXONE-AL01D-EV2			
	CX-Protocol Ver.1. □	Software to create protocol macros Note: Can be used with CJ1G/CJ1H version 1.2 or later, and with CJ1M version 1.3 and later. OS: Windows 98SE, Me, NT4.0 (Service Pack 6a), 2000 (Service Pack 3a or higher), XP, or Vista		1 license Media: CD			WS02-PSTC1-E	---

- Note 1.** The Serial Gateway function is enabled only for Serial Communications Units of unit version 1.2 and later.
Note 2. The no-protocol function is enabled only for Serial Communications Units of unit version 1.2 and later (and a CPU Unit of unit version 3.0 or later is also required).
Note 3. The Modbus-STU Slave function is enabled only for Serial Communications Units of unit version 1.3 and later.
Note 4. When an NT-AL001 RS-232C/RS-422A Conversion Unit is used, this value increases by 0.15 A/Unit. When a CJ1W-CIF11 RS-422A Conversion Unit is used, it increases by 0.04 A/Unit.
Note 5. Site licenses are available for the CX-One (3, 10, 30, or 50 licenses). For details, refer to *Support Software* on page 42.
Note 6. When purchasing the DVD format, verify the computer model and DVD drive specifications before purchasing.

■ Ethernet Unit

Unit classification	Product name	Specifications			No. of unit numbers allocated	Current consumption (A)		Model	Standards
		Communications cable	Communications functions	Max.Units mountable per CPU Unit		5 V	24 V		
CJ1 CPU Bus Unit	Ethernet Unit 	100Base-TX	FINS communications service (TCP/IP, UDP/IP), FTP server functions, socket services, mail transmission service, mail reception (remote command receive), automatic adjustment of PLC's built-in clock, server/host name specifications	4	1	0.37	---	CJ1W-ETN21	UC1, N, L, CE

■ Controller Link Units

● Controller Link Units, New Models

Unit classification	Product name	Specifications				No. of unit numbers allocated	Current consumption (A)		Model	Standards
		Communications cable	Communications type	Duplex support	Max. Units mountable per CPU Unit		5 V	24 V		
CJ1 CPU Bus Unit	 Controller Link Unit	Wired shielded twisted-pair cable (See note 2.)	Data links and message service	No	8	1	0.35	---	CJ1W-CLK23 NEW	UC1, N, L, CE

● Controller Link Units, Old Models

Unit classification	Product name	Specifications				No. of unit numbers allocated	Current consumption (A)		Model	Standards
		Communications cable	Communications type	Duplex support	Max. Units mountable per CPU Unit		5 V	24 V		
CJ1 CPU Bus Unit	Controller Link Unit	Wired shielded twisted-pair cable (See note 2.)	Data links and message service	No	8	1	0.35	---	CJ1W-CLK21-V1	UC1, N, L, CE

Note 1. New models are fully compatible with old models and provide enhanced functionality, such as an increase in the number of send words from 1,000 to 4,000 words.

Select a new model when ordering.

2. Use the following special cable for shielded, twisted-pair cable.

- ESVC0.5 × 2C-13262 (Bando Electric Wire: Japanese Company)
- ESN0.5 × 2C-99-087B (Nihon Electric Wire & Cable Corporation: Japanese Company)
- ESPC 1P × 0.5 mm² (Nagaoka Electric Wire Co., Ltd.: Japanese Company)
- Li2Y-FCY2 × 0.56qmm (Kromberg & Schubert, Komtec Department: German Company)
- 1 × 2 × AWG-20PE+Tr.CUSN+PVC (Draka Cables Industrial: Spanish Company)
- #9207 (Belden: US Company)
- Li2Y-FCY2×0.56qmm (Kromberg & Schubert, Komtec Department: German Company)
- 1×2×AWG-20PE+Tr.CUSN+PVC (Draka Cables Industrial: Spanish Company)
- #9207 (Belden: US Company)

● Controller Link Support Boards, New Models

Unit classification	Specification		Accessories	Model	Standards
	Communications cable	Communications type			
 Controller Link Support Board for PCI Bus	Wired shielded twisted-pair cable	Data link and message service	Communications Middleware FinsGateway Version 2003 and Version 3 are supplied.	3G8F7-CLK23-E NEW	CE

● Controller Link Support Boards, Old Models

Unit classification	Specification		Accessories	Model	Standards
	Communications cable	Communications type			
Controller Link Support Board for PCI Bus	Wired shielded twisted-pair cable	Data link and message service	Communications Middleware FinsGateway Version 2003 and Version 3 are supplied.	3G8F7-CLK21-EV1	CE

Note: New models are fully compatible with old models and provide enhanced functionality, such as an increase in the number of send words from 1,000 to 4,000 words. Select a new model when ordering.

● Repeater Units

Unit classification	Specifications	Model	Standards
 Controller Link Repeater Unit	Wire-to-wire Model	CS1W-RPT01	UC1, CE
	Wire-to-Optical (H-PCF) Model (See note 2.)	CS1W-RPT02	
	Wire-to-Optical (GI) Model (See note 3.)	CS1W-RPT03	

Note 1. Using Repeater Units enables T-branches and long-distance wiring for Wired Controller Link networks. 62-node configurations, and converting part of the network to optical cable.



- When using wire-to-optical (H-PCF) cable, use a H-PCF cable (for both Controller Link and SYSMAC LINK) or a H-PCF optical fiber cable with connector.
- When using wire-to-optical (GI) cable, use a GI optical cable (for Controller Link).

● Relay Terminal Block

Unit classification	Specifications	Model	Standards
Relay Terminal Block for Wired Controller Link Unit 	Use for Wired Controller Link Units (set of 5).	CJ1W-TB101	---

Note: Controller Link Units can be replaced without stopping the communications of the entire network if a Relay Terminal Block is installed in advance on the Unit in a Wired Controller Link network. Relay Blocks cannot be used on Controller Link Support Boards.

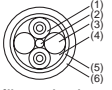
● H-PCF Cables and Optical Connectors

Name	Application/construction		Specifications	Model	Standards	
Optical Fiber Cables	Controller Link, SYSMAC LINK, SYSBUS	 (1) Optical fiber single-core cord (2) Tension member (plastic-sheathed wire) (3) Filler (plastic) (4) Filler surrounding signal wires (plastic, yarn, or fiber) (5) Holding tape (plastic) (6) Heat-resistant PV sheath	Two-core optical cable with tension member	Black 10 m	S3200-HCCB101	---
				Black 50 m	S3200-HCCB501	
				Black 100 m	S3200-HCCB102	
				Black 500 m	S3200-HCCB502	
				Black 1,000 m	S3200-HCCB103	
				Orange 10 m	S3200-HCCO101	
				Orange 50 m	S3200-HCCO501	
				Orange 100m	S3200-HCCO102	
				Orange 500 m	S3200-HCCO502	
				Orange 1,000 m	S3200-HCCO103	
Optical Connectors (Crimp-cut) 	CS1W-RPT02		Half lock	S3200-COCF2571		
			Full lock	S3200-COCF2071		

● **H-PCF Optical Fiber Cables with Connectors (Black Composite Cables with Two-Optical Lines and Two Power Supply Lines)**

Application	Appearance	Model	Standards
Controller Link, SYSMAC Link		S3200-CN□□□□-20-20	---
		S3200-CN□□□□-20-25	
		S3200-CN□□□□-25-25	

● **Cable Length**

The following cable lengths are available: 2 m, 5 m, 15 m, 20 m. For lengths of 21 m or more, contact your OMRON sales representative.

● **Model Numbers**

Lengths of 2 m, 5 m, 10 m, 15 m, and 20 m

Example: S3200-CN□□□□-20-25

Length of 21 m or more

Example: S3200-CN-20-20

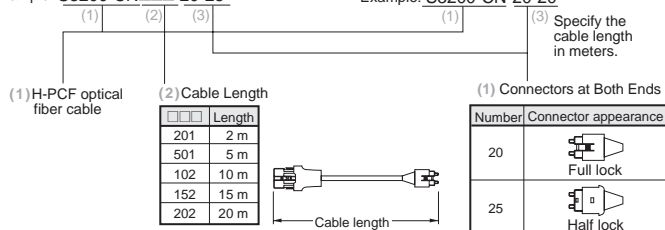

● **Optical Connector Assembly Tool**

Name	Applicable Unit	Model	Manufacturer	Standards
Optical Fiber Assembly Tool (See note.)	This tool is used on site for mounting crimp-cut connectors and hard plastic-clad silica optical fiber for optical transmission systems of SYSMAC C-series SYSBUS, SYSMAC LINK, and Controller Link.	CAK-0057	Sumitomo Electric Industries, Ltd.	---

Note: There is a risk of quality problems when using cables assembled by typical users, so we recommend purchasing cables with preattached connectors or having a qualified technician assemble the cables. Optical connectors for H-PCF Optical Cables with Connectors are adhesive polished.

● **GI Optical Cables**

A qualified technician must select, assemble, and install GI Optical Fiber Cable, so always let an optical cable specialist handle the GI cable.

Usable Optical Cables and Optical Connectors

- Optical fiber types: Graded, indexed, multi-mode, all quartz glass, fiber (GI-type AGF cable)
- Optical fiber construction (core diameter/clad diameter): 62.5/125 μm or 50/125 μm
- Optical fiber optical characteristics of optical fiber: Refer to the tables.
- Optical connector: ST connector (IEC-874-10)

● **50/125 μm AGF Cable**

Item	Minimum	Standard	Maximum	Remarks
Numerical Aperture (N.A)	---	0.21	---	---
Transmission loss (dB)	---	---	3.0 Lf	0.5 km ≤ Lf
			3.0 Lf + 0.2	0.2 km ≤ Lf ≤ 0.5 km
			3.0 Lf + 0.4	Lf ≤ 0.2 km
Connection loss (dB)	---	---	1.0	λ = 0.8 μm, one location
Transmission bandwidth (MHz-km)	500	---	---	λ = 0.85 μm (LD)

Lf is fiber length in km, Ta is ambient temperature, and λ: is the peak wavelength of the test light source.

● **62.5/125 μm AGF Cable**

Item	Minimum	Standard	Maximum	Remarks
Numerical Aperture (N.A)	---	0.28	---	---
Transmission loss (dB)	---	---	3.5 Lf	0.5 km ≤ Lf
			3.5 Lf + 0.2	0.2 km ≤ Lf ≤ 0.5 km
			3.5 Lf + 0.4	Lf ≤ 0.2 km
Connection loss (dB)	---	---	1.0	λ = 0.8 μm, one location
Transmission bandwidth (MHz-km)	200	---	---	λ = 0.85 μm (LD)

Lf is fiber length in km, Ta is ambient temperature, and λ is the peak wavelength of the test light source.

■ FL-net Unit

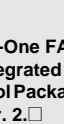
Unit classification	Product name	Specifications			No. of unit numbers allocated	Current consumption (A)		Model	Standards
		Communications interface	Communications functions	Max. Units mountable per CPU Units		5 V	24 V		
CJ1 CPU Bus Units	 FL-net Unit	100Base-TX	With FL-net Ver. 2.0 specifications (OPCN-2) Data links and message service	4	1	0.37	---	CJ1W-FLN22	UC1, CE
	 CX-One FA Integrated Tool Package Ver. 2.0	The CX-One is a package that integrates the Support Software for OMRON PLCs and components. CX-One runs on the following OS. Windows 98SE, Me, NT4.0 (Service Pack 6a), 2000 (Service Pack 3a or higher), XP, or Vista CX-One Ver. 2.0 includes CX-FLnet Ver. 1.0. For details, refer to the CX-One catalog (Cat. No. R134).			1 license Media: CD (See note 1.)		CXONE-AL01C-EV2		---
					1 license Media: DVD (See notes 1 and 2.)		CXONE-AL01D-EV2		

Note 1. Site licenses are available for the CX-One (3, 10, 30, or 50 licenses). For details, refer to *Support Software* on page 42.
2. When purchasing the DVD format, verify the computer model and DVD drive specifications before purchasing.

■ DeviceNet Unit

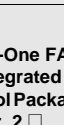
Unit classification	Product name	Specifications	Communications type	No. of unit numbers allocated	Current consumption (A)		Model	Standards
					5 V	24 V		
CJ1 CPU Bus Units	 DeviceNet Unit	Functions as master and/or slave; allows control of 32,000 points max. per master.	<ul style="list-style-type: none"> Remote I/O communications master (fixed or user-set allocations) Remote I/O communications slave (fixed or user-set allocations) Message communications 	1	0.29	---	CJ1W-DRM21	UC1, N, L, CE
	 CX-One FA Integrated Tool Package Ver. 2.0	The CX-One is a package that integrates the Support Software for OMRON PLCs and components. CX-One runs on the following OS. Windows 98SE, Me, NT4.0 (Service Pack 6a), 2000 (Service Pack 3a or higher), XP, or Vista CX-One Ver. 2.0 includes CX-Integrator Ver. 2.0. For details, refer to the CX-One catalog (Cat. No. R134).			1 license Media: DVD (See note 1.)		CXONE-AL01C-EV2	
					1 license Media: DVD (See notes 1 and 2.)		CXONE-AL01D-EV2	

Note 1. Site licenses are available for the CX-One (3, 10, 30, or 50 licenses). For details, refer to *Support Software* on page 42.
2. When purchasing the DVD format, verify the computer model and DVD drive specifications before purchasing.

■ CompoNet Master Unit

Unit classification	Product name	Specifications		No. of unit numbers allocated	Current consumption (A)		Model	Standards
		Communications functions	No. of I/O points per Master Unit		5 V	24 V		
CJ1 Special I/O Units	 CompoNet Master Unit	<ul style="list-style-type: none"> Remote I/O communications Message communications 	Word Slaves: 2,048 max. (1,024 inputs and 1,024 outputs) Bit Slaves: 512 max. (256 inputs and 256 outputs)	1, 2, 4, or 8	0.4	---	CJ1W-CRM21	U1, CE, UC1 certification pending

■ CompoBus/S Master Unit

Unit classification	Product name	Specifications			No. of unit numbers allocated	Current consumption (A)		Model	Standards
		Communications functions	No. of I/O points	Max. Units mountable per CPU Unit		5 V	24 V		
CJ1 Special I/O Units	 CompoBus/S Master Unit	Remote I/O communications	256 max. (128 inputs and 128 outputs) 128 max. (64 inputs and 64 outputs)	40	1 or 2 (variable)	0.15	---	CJ1W-SRM21	UC1, N, L, CE,

■ ID Sensor Units

Unit classification	Product name	Specifications			No. of unit numbers allocated	Current consumption (A)		Model	Standards
		Connected ID Systems	No. of connected R/W heads	External power supply		5 V	24 V		
CJ1 CPU Bus Units	ID Sensor Units 	V680 Series RFID System	1	Not required.	1	0.26 (See note.)	0.13 (See note.)	CJ1W-V680C11 ^{NEW}	UC, CE certification pending
			2		2	0.32	0.26	CJ1W-V680C12 ^{NEW}	
		V600 Series RFID System	1	Not required.	1	0.26	0.12	CJ1W-V600C11	UC, CE
			2		2	0.32	0.24	CJ1W-V600C12	

Note: To use a V680-H01 Antenna, refer to the *V680 Series RFID System Catalog* (Cat. No. Q151).

■ SYSMAC SPU (High-speed Data Storage Unit)

Unit classification	Product name	Specifications		No. of unit numbers allocated	Current consumption (A)		Model	Standards	
		PC Card slot	Ethernet (LAN) port		5 V	24 V			
CJ1 CPU Bus Units	SYSMAC SPU Ver. 2 (High-speed Data Storage Unit) 	CF Card Type I/II × 1 slot Use an OMRON HMC-EF□□□ Memory Card.	1 port (10/100Base-TX)	1	0.56	---	CJ1W-SPU01-V2 ^{NEW}	UC1, CE	
	SPU-Console Ver. 2.0	Functions: Unit settings, sampling settings, etc., for High-speed Data Collection Units (required for making settings for this Unit) OS: Windows 2000 or XP						WS02-SPTC1-V2 ^{NEW}	
	Ver. 2.0 SYSMAC SPU Data Management Middleware Ver. 2.0	Function: Data files collected by SYSMAC SPU Data Management Middleware are automatically acquired at the personal computer, and can be registered in a database. OS: Windows 2000 or XP				1 license		WS02-EDMC1-V2	---
						5 licenses		WS02-EDMC1-V2L05	
Memory Cards	Flash memory, 128 MB				Note: Memory Card is required for data collection.		HMC-EF183	N, L, CE	
	Flash memory, 256 MB (SYSMAC SPU only)								HMC-EF283
	Flash memory, 512 MB (SYSMAC SPU only)								HMC-EF583

Read and Understand this Catalog

Please read and understand this catalog before purchasing the products. Please consult your OMRON representative if you have any questions or comments.

Warranty and Limitations of Liability

WARRANTY

OMRON's exclusive warranty is that the products are free from defects in materials and workmanship for a period of one year (or other period if specified) from date of sale by OMRON.

OMRON MAKES NO WARRANTY OR REPRESENTATION, EXPRESS OR IMPLIED, REGARDING NON-INFRINGEMENT, MERCHANTABILITY, OR FITNESS FOR PARTICULAR PURPOSE OF THE PRODUCTS. ANY BUYER OR USER ACKNOWLEDGES THAT THE BUYER OR USER ALONE HAS DETERMINED THAT THE PRODUCTS WILL SUITABLY MEET THE REQUIREMENTS OF THEIR INTENDED USE. OMRON DISCLAIMS ALL OTHER WARRANTIES, EXPRESS OR IMPLIED.

LIMITATIONS OF LIABILITY

OMRON SHALL NOT BE RESPONSIBLE FOR SPECIAL, INDIRECT, OR CONSEQUENTIAL DAMAGES, LOSS OF PROFITS, OR COMMERCIAL LOSS IN ANY WAY CONNECTED WITH THE PRODUCTS, WHETHER SUCH CLAIM IS BASED ON CONTRACT, WARRANTY, NEGLIGENCE, OR STRICT LIABILITY.

In no event shall the responsibility of OMRON for any act exceed the individual price of the product on which liability is asserted.

IN NO EVENT SHALL OMRON BE RESPONSIBLE FOR WARRANTY, REPAIR, OR OTHER CLAIMS REGARDING THE PRODUCTS UNLESS OMRON'S ANALYSIS CONFIRMS THAT THE PRODUCTS WERE PROPERLY HANDLED, STORED, INSTALLED, AND MAINTAINED AND NOT SUBJECT TO CONTAMINATION, ABUSE, MISUSE, OR INAPPROPRIATE MODIFICATION OR REPAIR.

Application Considerations

SUITABILITY FOR USE

OMRON shall not be responsible for conformity with any standards, codes, or regulations that apply to the combination of products in the customer's application or use of the products.

Take all necessary steps to determine the suitability of the product for the systems, machines, and equipment with which it will be used.

Know and observe all prohibitions of use applicable to the products.

NEVER USE THE PRODUCTS FOR AN APPLICATION INVOLVING SERIOUS RISK TO LIFE OR PROPERTY WITHOUT ENSURING THAT THE SYSTEM AS A WHOLE HAS BEEN DESIGNED TO ADDRESS THE RISKS, AND THAT THE OMRON PRODUCTS ARE PROPERLY RATED AND INSTALLED FOR THE INTENDED USE WITHIN THE OVERALL EQUIPMENT OR SYSTEM.

PROGRAMMABLE PRODUCTS

OMRON shall not be responsible for the user's programming of a programmable product, or any consequence thereof.

Disclaimers

CHANGE IN SPECIFICATIONS

Product specifications and accessories may be changed at any time based on improvements and other reasons. Consult with your OMRON representative at any time to confirm actual specifications of purchased products.

DIMENSIONS AND WEIGHTS

Dimensions and weights are nominal and are not to be used for manufacturing purposes, even when tolerances are shown.

PERFORMANCE DATA

Performance data given in this catalog is provided as a guide for the user in determining suitability and does not constitute a warranty. It may represent the result of OMRON's test conditions, and the users must correlate it to actual application requirements. Actual performance is subject to the OMRON *Warranty and Limitations of Liability*.



Note: Do not use this document to operate the Unit.

OMRON Corporation
Industrial Automation Company
Control Devices Division H.Q.
PLC Division

Shiokoji Horikawa, Shimogyo-ku,
Kyoto, 600-8530 Japan
Tel: (81) 75-344-7084/Fax: (81) 75-344-7149

Regional Headquarters

OMRON EUROPE B.V.
Wegalaan 67-69-2132 JD Hoofddorp
The Netherlands
Tel: (31)2356-81-300/Fax: (31)2356-81-388

OMRON Industrial Automation Global: www.ia.omron.com

OMRON ELECTRONICS LLC
One Commerce Drive Schaumburg,
IL 60173-5302 U.S.A.
Tel: (1) 847-843-7900/Fax: (1) 847-843-7787

OMRON ASIA PACIFIC PTE. LTD.
No. 438A Alexandra Road # 05-05/08 (Lobby 2),
Alexandra Technopark, Singapore 119967
Tel: (65) 6835-3011/Fax: (65) 6835-2711

OMRON (CHINA) CO., LTD.
Room 2211, Bank of China Tower,
200 Yin Cheng Zhong Road,
PuDong New Area, Shanghai, 200120, China
Tel: (86) 21-5037-2222/Fax: (86) 21-5037-2200

Authorized Distributor:

In the interest of product improvement,
specifications are subject to change without notice.

Cat. No. P052-E1-07

Printed in Japan
1208